

INSTRUCTION MANUAL FOR

BLUED &
STAINLESS
STEEL



CALIBERS

.22 Hornet, .218 Bee, .223, .22-250,
.220 Swift, 6mm Rem., .243, .257 Roberts,
.25-06, .270 Win., .280 Rem., 7x57mm,
7mm Rem. Mag., .7mm STW,
.308 Win. Mag., 30-06, .300 Win. Mag.,
.338 Mag., .270 Weatherby, .300 Weatherby,
.375 H&H, .416 Rem., .416 Rigby, .45-70,
.458 Mag., & .458 Lott

RUGER® **NO. 1** SINGLE SHOT RIFLES



**READ THE INSTRUCTIONS AND
WARNINGS IN THIS MANUAL CAREFULLY
BEFORE USING THIS FIREARM**

**For Product Service on This Model Please Call:
(603) 865-2442 (See p. 26)**

**STURM, RUGER & Company, Inc.
Southport, Connecticut 06490 U.S.A.**

THIS INSTRUCTION MANUAL SHOULD ALWAYS ACCOMPANY THIS FIREARM AND BE TRANSFERRED WITH IT UPON CHANGE OF OWNERSHIP, OR WHEN THE FIREARM IS LOANED OR PRESENTED TO ANOTHER PERSON.

State-By-State Warnings

Certain states require by law that their own specified warning notices in larger-than-normal type be conspicuously included by the manufacturer, distributor, or retail dealer with firearms sold in that state. Sturm, Ruger sells its products in compliance with applicable laws and regulations. Because our products may be sold in these states, we include the following:

California:

⚠ WARNING

“Children are attracted to and can operate firearms that can cause severe injuries or death. Prevent child access by always keeping guns locked away and unloaded when not in use. If you keep a loaded firearm where a child obtains and improperly uses it, you can be fined or sent to prison.”

⚠ ADVERTENCIA

“A los niños los atraen las armas de fuego y las pueden hacer funcionar. Ellos pueden causarse lesiones graves y la muerte. Evite que los niños tengan acceso a las armas de fuego guardándolas siempre con llave y descargadas cuando no las esté utilizando. Si usted tiene un arma de fuego cargada en un lugar en que un niño tiene acceso a ella y la usa indebidamente, le pueden dar una multa o enviarlo a la cárcel.”

Connecticut:

“UNLAWFUL STORAGE OF A LOADED FIREARM MAY RESULT IN IMPRISONMENT OR FINE.”

Florida:

“IT IS UNLAWFUL, AND PUNISHABLE BY IMPRISONMENT AND FINE, FOR ANY ADULT TO STORE OR LEAVE A FIREARM IN ANY PLACE WITHIN THE REACH OR EASY ACCESS OF A MINOR UNDER 18 YEARS OF AGE OR TO KNOWINGLY SELL OR OTHERWISE TRANSFER OWNERSHIP OR POSSESSION OF A FIREARM TO A MINOR OR A PERSON OF UNSOUND MIND.”

Maine:

“ENDANGERING THE WELFARE OF A CHILD IS A CRIME. IF YOU LEAVE A FIREARM AND AMMUNITION WITHIN EASY ACCESS OF A CHILD, YOU MAY BE SUBJECT TO FINE, IMPRISONMENT OR BOTH. KEEP FIREARMS AND AMMUNITION SEPARATE. KEEP FIREARMS AND AMMUNITION LOCKED UP. USE TRIGGER LOCKS.”

Maryland:

“WARNING: Children can operate firearms which may cause death or serious injury. It is a crime to store or leave a loaded firearm in any location where an individual knew or should have known that an unsupervised minor would gain access to the firearm. Store your firearm responsibly!”

Massachusetts:

“WARNING FROM THE MASSACHUSETTS ATTORNEY GENERAL: This handgun is not equipped with a device that fully blocks use by unauthorized users. More than 200,000 firearms like this one are stolen from their owners every year in the United States. In addition, there are more than a thousand suicides each year by younger children and teenagers who get access to firearms. Hundreds more die from accidental discharge. It is likely that many more children sustain serious wounds, or inflict such wounds accidentally on others. In order to limit the chance of such misuse, it is imperative that you keep this weapon locked in a secure place and take other steps necessary to limit the possibility of theft or accident. Failure to take reasonable preventive steps may result in innocent lives being lost, and in some circumstances may result in your liability for these deaths.”

“IT IS UNLAWFUL TO STORE OR KEEP A FIREARM, RIFLE, SHOTGUN OR MACHINE GUN IN ANY PLACE UNLESS THAT WEAPON IS EQUIPPED WITH A TAMPER-RESISTANT SAFETY DEVICE OR IS STORED OR KEPT IN A SECURELY LOCKED CONTAINER.”

New Jersey:

“IT IS A CRIMINAL OFFENSE TO LEAVE A LOADED FIREARM WITHIN EASY ACCESS OF A MINOR.”

New York City:

“THE USE OF A LOCKING DEVICE OR SAFETY LOCK IS ONLY ONE ASPECT OF RESPONSIBLE WEAPONS STORAGE. ALL WEAPONS SHOULD BE STORED UNLOADED AND LOCKED IN A LOCATION THAT IS BOTH SEPARATE FROM THEIR AMMUNITION AND INACCESSIBLE TO CHILDREN AND ANY OTHER UNAUTHORIZED PERSONS.”

North Carolina:

“IT IS UNLAWFUL TO STORE OR LEAVE A FIREARM THAT CAN BE DISCHARGED IN A MANNER THAT A REASONABLE PERSON SHOULD KNOW IS ACCESSIBLE TO A MINOR.”

Texas:

“IT IS UNLAWFUL TO STORE, TRANSPORT, OR ABANDON AN UNSECURED FIREARM IN A PLACE WHERE CHILDREN ARE LIKELY TO BE AND CAN OBTAIN ACCESS TO THE FIREARM.”

Wisconsin:

“IF YOU LEAVE A LOADED FIREARM WITHIN THE REACH OR EASY ACCESS OF A CHILD YOU MAY BE FINED OR IMPRISONED OR BOTH IF THE CHILD IMPROPERLY DISCHARGES, POSSESSES, OR EXHIBITS THE FIREARM.”

* * * * *

Please check with your licensed retailer or state police for additional warnings which may be required by local law or regulation. Such regulations change constantly, and local authorities are in the best position to advise you on such legal matters.



WARNING – LOCKING DEVICES

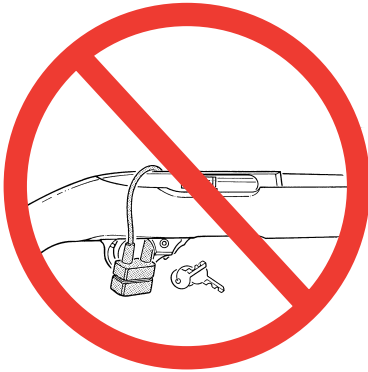

**DO NOT INSTALL
INSIDE TRIGGER GUARD**

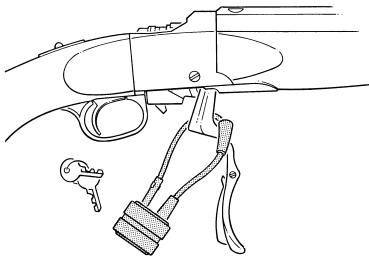

**INSTALL LOCK
AS SHOWN HERE**

This firearm was originally sold with a key-operated locking device. While it can help provide secure storage for your **unloaded** firearm, any locking device can fail. All guns are designed to fire if they are loaded and the trigger is pulled. Therefore, **never install the locking device inside the trigger guard or in any way that it can possibly pull the trigger!** Do not leave the keys in the lock.

The ultimate responsibility for secure storage of any firearm must depend upon its owner and his or her individual circumstances.

Guns should be securely stored unloaded, in a secure location, separate from their ammunition.

See “Storage Warning”, page 22.

**NEVER INSTALL
LOCKING DEVICE
INSIDE TRIGGER GUARD**

FIREARMS SAFETY-YOUR RESPONSIBILITY

SAFETY MUST BE THE FIRST AND CONSTANT CONSIDERATION OF EVERY PERSON WHO HANDLES FIREARMS AND AMMUNITION.

This Instruction Manual is designed to assist you in learning how to use and care for your **RUGER® NO. 1** rifle properly.

Only when you are certain you fully understand the Manual and can properly carry out its instructions should you practice loading, etc. with live ammunition. If you have any doubts about your ability to handle or use a particular type of gun safely, then you should seek supervised instruction. Such personalized instruction is often available from gun dealers, gun clubs or police departments. If none of these sources can help you, write to the National Rifle Association, 11250 Waples Mill Road, Fairfax, VA 22030-7400. They will assist you.

The person with a gun in their possession has a full-time job. You cannot guess; you cannot forget. You must know how to use your firearm safely. **Do not use any firearm without having a complete understanding of its particular characteristics and safe use.** Remember: There is no such thing as a foolproof gun.

TABLE OF CONTENTS

	Page
General Information	7
Operation of Safety	8
Ammunition	10
To Load and Fire	11
To Unload Rifle	14
Cartridge Extraction and Ejection	15
To Clear a Malfunction ("Jam")	15
To Minimize Malfunctions ("Jams")	16
Basic Disassembly and Reassembly	17 - 20
Care and Cleaning	20
Storage	21
Quick Detachable Sling Swivel	23
Attaching Ruger Scope Rings	24
Sight Adjustment	25
Service and Parts Policy	26
Parts Drawings	34
The Basic Rules of Safe Firearms Handling	35
Warranty Information	40

"Ruger" is a registered U.S. trademark.



WARNINGS OF GREAT IMPORTANCE ARE FOUND ON THE FOLLOWING PAGES:

Locking Devices	5	Trigger Adjustment	13
Alterations	7	Unloading	14
Manual Safety	10	Malfunctions	16
Ammunition	10	Disassembly	17
Lead Exposure	11	Lubrication	21
Loading	11	Storage	22
Handling	12	Parts Purchasers	27
Firing	13		

OTHER CAUTIONS AND WARNINGS APPEAR THROUGHOUT THE MANUAL.

**FIREARMS ARE DANGEROUS WEAPONS—
READ THE INSTRUCTIONS AND WARNINGS
IN THIS MANUAL THOROUGHLY AND CAREFUL-
LY BEFORE USING.**



WARNING—ALTERATIONS



This product was designed to function properly in its original condition. Alterations can make it unsafe. Do not alter any part or add or substitute parts or accessories not made by Sturm, Ruger & Co. Inc.

DO NOT ALTER ANY GUN

GENERAL INFORMATION AND MECHANICAL CHARACTERISTICS

The **RUGER® NO. 1** is an under-lever, falling-block, single-shot rifle. Although it follows in some characteristics the Farquharson design, in mechanical details it embodies features never previously found in rifles of this type.

The No. 1 receiver forms a rigid connection between the barrel and butt stock. The butt stock is mortised into the receiver, and a longitudinal bolt passes through the stock and binds the stock and receiver together. A heavy steel extension from the receiver is used for forearm attachment. The concealed hammer is retracted upon the first opening motion of the lever and can never strike the firing pin unless the breech block is fully elevated into firing position. The swinging transfer block functions to virtually lock the firing pin in its

forward position against gas pressure during firing. The action handles rimmed, semi-rimmed, rimless and belted cartridges, and the extractor-ejector mechanism provides great leverage with only moderate force applied to the lever.

RUGER® NO. 1 rifles are manufactured in blued steel, stainless steel, lightweight, standard, and heavyweight barrel models, with “semi-beavertail”, “Alexander Henry”, and “International” (full-length) style walnut forends, or weather resistant laminated hardwood in the case of the stainless steel models. They are all mechanically identical and all versions incorporate integral scope mount bases.

All mechanical components are made of heat-treated chrome-molybdenum or stainless steel with music wire coil springs throughout the mechanism. The rifle is equally usable by right-hand and left-hand shooters.

NOMENCLATURE

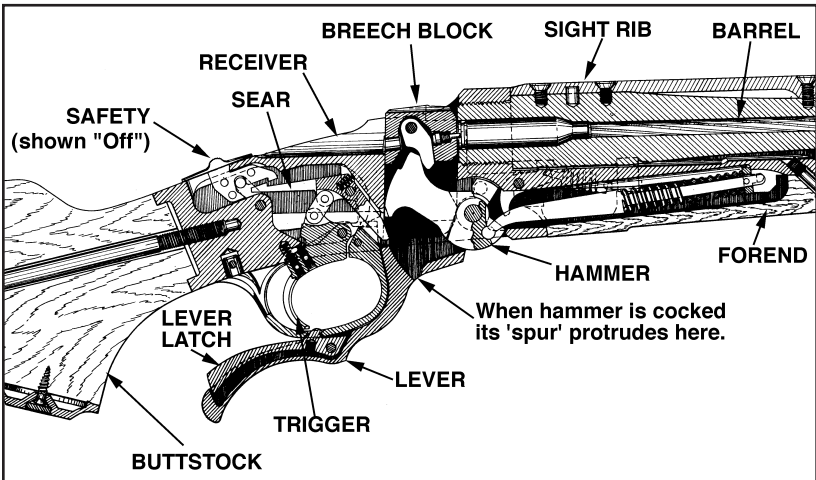

Figure 1. In this illustration the rifle has just been fired and an empty cartridge case is shown in the chamber. The manual safety is shown in its forward “FIRE” (“OFF”) position, permitting the sear to release the hammer and the rifle to fire. **The safety selector should always be “ON” in its rearmost “SAFE” position whenever the rifle is not actually being fired.** See page 9.

OPERATION OF SAFETY

The **RUGER® NO. 1** rifle has a two-position, ambidextrous manual safety located atop the rear of the receiver. It is operated by sliding it fully backward and forward with the thumb.

The safety can be moved to the safe position *only* when the hammer is cocked. Fully operating the under lever cocks the rifle. The rifle can be loaded and unloaded while the safety is in the “Safe” position. The safety mechanism blocks movement of the sear, and retracts the hammer slightly. It is the retracting of the hammer which creates the feeling of ‘resistance’ when the safety is being moved to the “Safe” position. When the hammer is cocked, the hammer spur protrudes slightly below the lever. See the notation in Figure 1. The protrusion of the hammer serves as a cocking indicator that can be felt and seen.

When the rifle is loaded, unless it is to be fired immediately, THE SAFETY SHOULD BE AT ITS EXTREME REARWARD POSITION with the word “SAFE” fully visible (on some older models the letter “S” appears). When operating the safety (with the thumb) the user will feel additional resistance to movement of the safety *before* it reaches its extreme rearward position. That resistance should *not* be assumed to indicate the safety is in the safe position.

Practice with an unloaded rifle, moving the safety into the “Safe” and “Fire” positions until you know the safety position’s correct positions. See Figures 2 and 3, below.

WARNING: When manipulating the safety, DO NOT HAVE ANY FINGER INSIDE THE TRIGGER GUARD! When the safety selector is in the “Fire” position and the trigger is pulled, the rifle will fire.

The safety selector should always be in the “Safe” position except when the gun user is actually firing or unloading the rifle. The safety selector should unflinchingly be moved to the “Safe” position when the gun user ceases firing.

SAFETY POSITIONS

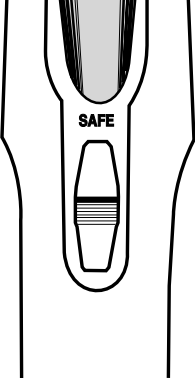

Figure 2. Safety selector in “SAFE” (full rearward) position. The safety selector should be in this position when the under-lever is open to load a cartridge, or to unload a live round. Whenever a cartridge is chambered, the safety selector should be in the “SAFE” position unless the rifle is to be fired immediately. **Keep the safety in this position except when actually firing.** (When the safety is in the “SAFE” position, it is referred to as being “on.”)



Figure 3. Safety selector in “FIRE” (full forward) position. **The safety selector should be moved to this position only when the gun user is actually firing the rifle.** If you chose not to fire, **immediately** return the safety to the “SAFE” position shown in Figure 2. When the safety is in the “FIRE” position, it is referred to as being “off.”

The safety selector is held in each of its positions by a spring. Therefore, the gun user should frequently check the position of the safety selector to be certain it has not been inadvertently moved. If the safety does not function properly, or if the selector seems to move too easily, or if the safety selector does not seem firmly positioned in either of its positions, stop using the rifle and return it to the Newport Product Service Department for repair (See p. 26).

 <h2 style="margin: 0;">WARNING – MANUAL SAFETY</h2>	
	<p>Keep the safety on unless actually firing. Always move the safety fully to its intended position and check it. The safety has two positions –“SAFE” (also used for loading and unloading) and “FIRE.” The safety is not on “SAFE” until it is “clicked” fully rearward and the word “SAFE” is fully visible. Never depend on a safety mechanism or any other mechanical device to justify careless handling or permitting the rifle to point in an unsafe direction. The only “safe” rifle is one in which the breech block is open and the chamber is empty.</p>
<h3 style="margin: 0;">KNOW HOW TO USE THE SAFETY</h3>	

AMMUNITION

RUGER® NO. 1 rifles are chambered for many of the most popular factory-loaded cartridges manufactured in accordance with U.S. industry practice. The particular caliber for each rifle is rollmarked on the barrel. **Use cartridges only of the designated caliber that is marked on the barrel.** Please see AMMUNITION WARNING below and LOADING WARNING on page 11.

AMMUNITION (CARTRIDGES) NOTICE

WE SPECIFICALLY DISCLAIM RESPONSIBILITY FOR ANY DAMAGE OR INJURY WHATSOEVER OCCURRING IN CONNECTION WITH, OR AS A RESULT OF, THE USE IN ANY RUGER FIREARMS OF FAULTY, OR NON-STANDARD, OR “REMANUFACTURED” OR HAND-LOADED (RELOADED) AMMUNITION, OR OF CARTRIDGES OTHER THAN THOSE FOR WHICH THE FIREARM WAS ORIGINALLY CHAMBERED.

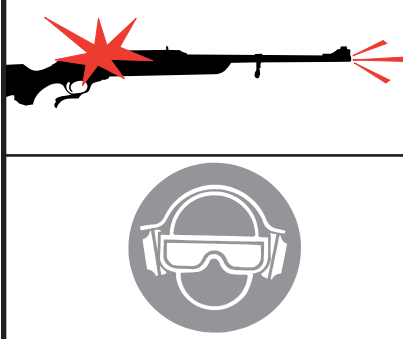
 <h2 style="margin: 0;">WARNING – AMMUNITION</h2>	
	<p>Death, serious injury, and damage can result from the use of wrong ammunition, bore obstructions, powder overloads, or incorrect cartridge components. Even the strongest gun can be blown up by excess pressure. Only use correct ammunition loaded to U.S. Industry Standards. Always wear shooting glasses and hearing protectors.</p>
<h3 style="margin: 0;">IMPROPER AMMUNITION DESTROYS GUNS</h3>	



WARNING – LEAD EXPOSURE



Discharging firearms in poorly ventilated areas, cleaning firearms, or handling ammunition may result in exposure to lead and other substances known to the state of California to cause birth defects, reproductive harm, and other serious physical injury. Have adequate ventilation at all times. Wash hands thoroughly after exposure.

**SHOOTING OR CLEANING GUNS
MAY EXPOSE YOU TO LEAD**

TO LOAD AND FIRE

Practice the important aspects of gun handling described below (with an unloaded rifle) until you can perform each of the steps with skill and confidence. **But before loading the rifle, please read completely through this manual, and be certain the muzzle is pointing in a safe direction. Do not load the rifle until you are ready to use it!**

1. **With the rifle pointed in a safe direction** (See Rule 2, p. 35), press the lever latch and fully lower the lever. This will expose the breech end of the chamber.
2. Move the safety selector fully rearward to the “Safe” position (see Figure 2, p. 9).
3. Insert a cartridge of the correct caliber into the chamber **only when you are ready to shoot.**



WARNING – LOADING



Know the caliber of your rifle you are loading and load cartridges of only that caliber into it!

Before loading, be certain the primer of each cartridge is seated flush with, or below, the surface of the cartridge case base. A cartridge discharged by the closing of the breech mechanism can result in possible serious injury to the shooter and those nearby.

If a cartridge does not chamber readily, do not force it. Check the bore and chamber to be certain that they are free of obstructions and that each cartridge is the proper caliber and of correct dimensions. If you cannot determine why the cartridge will not fit, clear the rifle of all cartridges and write or call the factory.

The wrong ammunition can destroy your gun and result in serious injury.



**BE SURE WHAT YOU LOAD
IS CORRECT**

4. Raise the lever fully until the lever latch engages, closing and locking the breech block. (Note: On the upward stroke of the lever, the breech block is locked before the lever latch engages. However, the rifle should not be fired or “dry fired” unless the lever latch is engaged.)

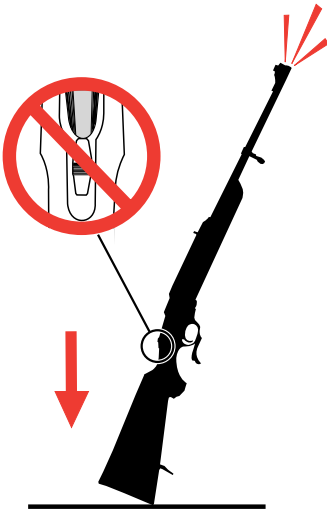
 WARNING – HANDLING	
	<p>Never carry the rifle loaded with the safety selector in the “FIRE” position. If dropped or struck with the safety off, the rifle may fire. Such a discharge can occur with or without the trigger being directly struck or touched. Never rest a loaded rifle against any object. (wall, fence, vehicle, tree, etc.) because there is always the possibility that the rifle will be jarred or slide from its position and fall with sufficient force to discharge. Keep safety on unless actually firing.</p> <p>Never lower (uncock) the firing pin with a loaded cartridge in the chamber. Under such circumstances the firing pin will be in direct contact with the primer of the loaded cartridge and a light accidental blow to the firing pin can readily cause the gun to discharge.</p>
ANY GUN MAY FIRE IF DROPPED	

	WARNING: DO NOT TOUCH THE TRIGGER UNTIL YOU ARE ACTUALLY READY TO FIRE THE RIFLE.
---	--

5. The rifle is now loaded and cocked, and the safety is engaged.
6. To fire the rifle, **with the rifle pointing in a safe direction**, push the safety forward to the “Fire” position, *then* place the index finger on the trigger and squeeze it. Pulling (squeezing) the trigger will discharge the cartridge. **Always be certain that you know where the bullet will strike when you fire the rifle.** Keep the thumb off of the safety when firing, as recoil can cause it to bruise the thumb.



WARNING – FIRING

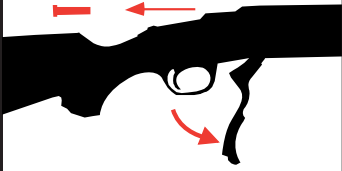

When firing the No. 1 rifle be sure that bystanders are well clear of the shooter and standing a safe distance to the rear. Empty cartridge cases are hot and are normally ejected from the rifle to the rear with some force. They could cause injury to any person who is standing too closely behind the shooter. Shooters should be particularly cautious concerning ejected cartridge cases striking the face. Tilt the rifle away from you when opening the lever. Always wear shooting glasses and hearing protectors.



EJECTED BRASS IS HOT



WARNING – TRIGGER ADJUSTMENT



This precision trigger has been carefully adjusted at the factory and permanently secured. Do not alter any factory setting! You can create an unsafe condition and the rifle may fire unexpectedly, or not fire at all.

You should be especially careful to keep the safety on at all times except when actually firing and keep your finger off the trigger unless you are squeezing it to fire, in order to minimize the possibility of accidental discharge.

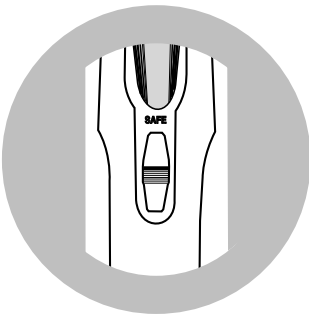

**DO NOT TAMPER
WITH TRIGGER
KEEP SAFETY ON UNLESS FIRING**



WARNING – UNLOADING

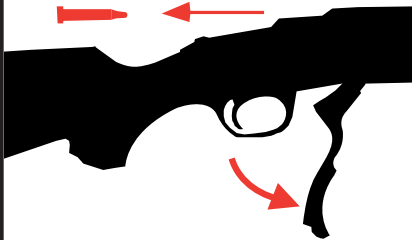

When there is a cartridge in the chamber and the safety selector is in the “Fire” position, the cartridge will discharge if the trigger is pulled. It is absolutely essential for the user to know how to completely unload it.

“Completely” means fully opening the lever, removing a chambered cartridge, and checking to be sure the rifle is empty. **The safety selector should always be in the “Safe” position when the rifle is being unloaded.** See the “Operation of Safety” section of this manual.

ALWAYS CHECK TO BE SURE RIFLE IS UNLOADED

TO UNLOAD RIFLE

(Keep the Rifle Pointed in a Safe Direction)

UNLOAD THE RIFLE IMMEDIATELY WHEN YOU ARE FINISHED SHOOTING.

1. Move the safety selector fully to the “Safe” position if the rifle is cocked.
2. Depress the lever latch and fully lower the lever to open the breech and to eject the chambered cartridge.
3. Inspect the chamber to be certain the cartridge has been extracted. Leave the breech block open.

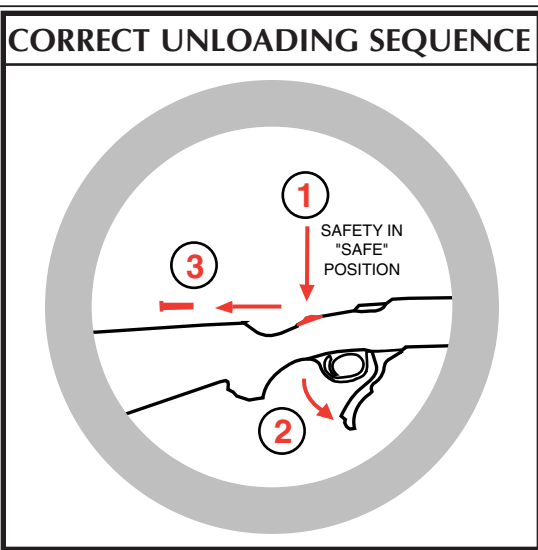

4. If you wish to store the rifle with the action shut, after making sure the chamber is empty, fully shut the lever.
5. Move the safety selector to the “Fire “ position and **with the rifle pointed in a safe direction, pull the trigger.**

CARTRIDGE EXTRACTION AND EJECTION

When the lever is lowered the fired cartridge case is automatically extracted and ejected. Check the chamber to be sure it is empty before closing the lever. If automatic ejection is not desired, remove the forearm and back-off the ejector strut adjustment screw until the ejector spring unit can be removed.

(See Figure 4) The ejector will then function as an extractor only, and the cartridge (or fired cartridge case) will be partially removed from the chamber by the final downward motion of the lever. If the ejector spring unit is replaced, do not over-tighten the ejector strut adjustment screw because that will bind the action. The force of ejection can be altered to some extent by moving the adjustment screw.

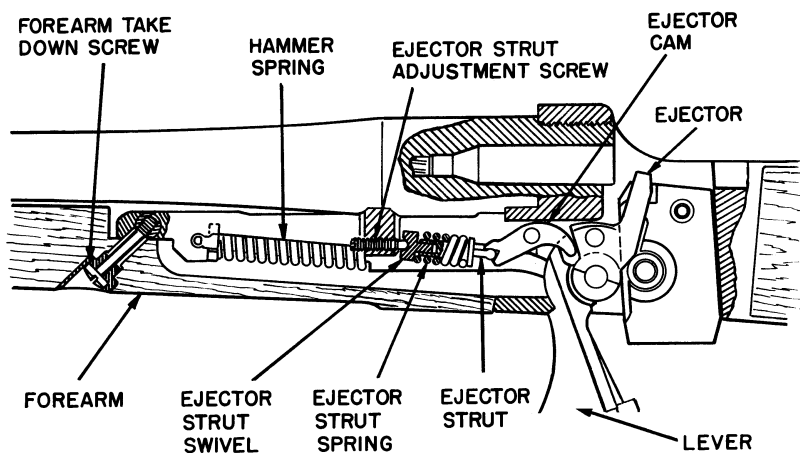

Figure 4



TO CLEAR A MALFUNCTION (“JAM”)

If a jam occurs, immediately put the safety selector in the “Safe” position and be certain the muzzle of the rifle is at all times pointing in a safe direction.

Then study the situation to determine the nature of the jam and how best to clear it.

- If a cartridge or fired case is caught between the breech block and the barrel, or if it is not extracted and remains in the chamber, don’t try to force the lever shut. Lower the lever and breech block fully and carefully remove the jammed cartridge or case.
- When attempting to extract a cartridge that is “stuck” in the chamber do not use any type of tool that is likely to act as a “firing pin” and discharge the cartridge should the tool impact on the primer.

- After clearing a jam, inspect the gun mechanism to determine if dirt might be the cause of the problem. Excess lubricant or grease can cause cartridges to feed sluggishly or fail to extract. An accumulation of grease or dirt on the face or sides of the breech block, under the extractor, or in the chamber can contribute to cartridge feeding problems. (See section on “Care and Cleaning”, p. 20).
- After clearing a jam, inspect all cartridges that have been removed from the gun. Safely dispose of any cartridges which are in any way damaged.
- If it appears that the rifle is not at fault and that the jam was caused by the type of cartridge being used, then try another type.
- Examine your fired cartridge cases. If they have split, blown or bulged heads, stop using that ammunition and promptly return the rifle to the factory for examination.
- If the above procedures do not result in a smooth and reliable feeding firearm, don't use the rifle. The **RUGER® NO. 1** can be returned directly to our Newport Product Service Department for inspection and repair, if required. See the “Service and Parts Policy” section of the manual for packing and shipping information.

 WARNING – MALFUNCTIONS	
	<p>If a cartridge hangs up, jams, or binds when being chambered or when the breech block is closed, do not attempt to force it into the chamber by pushing or striking the lever. Most failures of a cartridge to feed or to chamber are caused by ammunition that is incorrect, dirty, or defective.</p> <p>Whatever the cause, the gun user must, above all, recognize that jams can result in the very potentially dangerous situation of a cartridge discharging before it is chambered. If this occurs, the cartridge case will rupture and its fragments will fly out of the gun with sufficient force to cause injury. Always wear shooting glasses and hearing protectors!</p>
	STRIKING PRIMER CAN BURST CARTRIDGE

TO MINIMIZE MALFUNCTIONS (“JAMS”)

Firearms of all makes and types are susceptible to occasional malfunctioning due to a cartridge not feeding into the chamber, or due to a cartridge or fired case not being extracted and ejected.

To minimize the possibility of such occurrences the gun user should:

- Use ammunition of the correct caliber and type which is loaded to U.S. Industry Specifications. Do not use cartridges that are deformed, or cartridges that have been reloaded.
- Clean and lubricate the gun in accordance with the instructions in this manual.
- Learn to correctly operate the lever and how to properly load and empty the chamber.
- If the mechanism shows signs of not functioning correctly, or if a part is damaged or broken – don't use the rifle. Have it inspected and repaired.

For most repairs we recommend that Ruger guns be returned to the factory. However, if a gun has a cartridge in it which cannot be removed, then it is a violation of Federal Regulations to ship that loaded gun whether it be by U.S. Mail or by common carrier. Contact our Newport Product Service Department at (603) 865-2442.

BASIC DISASSEMBLY AND REASSEMBLY

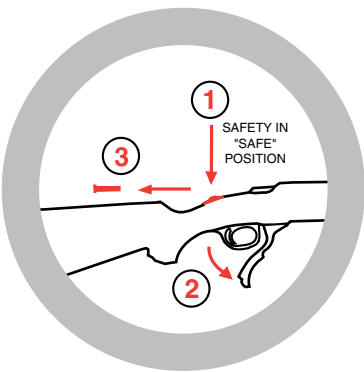
 WARNING – DISASSEMBLY	
	Always unload a firearm before cleaning, lubrication, disassembly or assembly.
UNLOAD BEFORE CLEANING	

It is preferable to carry out these procedures on a workbench or table which has a covered top. A piece of shallow nap rug or an old, coarse blanket is an ideal covering. Such a covering not only reduces the chances of the rifle slipping and being scratched, but it serves also to trap pins, plungers and springs that may otherwise get lost. It is advisable to have a container – such as a shoebox – in which each part can be placed as it is removed from the gun.

Before attempting to disassemble the rifle for the first time, study the parts drawing and parts list so as to be familiar with the relative position, appearance and name of each part. Carry out the disassembly slowly, and carefully note the

position of the part in the gun before starting to remove it. If a part is under spring tension (such as, the Safety or Trigger) remove it cautiously and anticipate the direction the spring and plunger are most likely to “jump.”

WARNING: If a spring or plunger become lost do not use a substitute. Springs of correct tension are vital to the safe and reliable performance of firearms. Before starting disassembly, remove the sling, scope and rings and place the rear sight blade in its down flat position.

DISASSEMBLY

(Rifle Must Be Unloaded Prior To Disassembly)

1. **Keep the rifle pointed in a safe direction!** Open the underlever and put the safety in the “Safe” position.
2. **CHECK TO BE CERTAIN THAT THE CHAMBER IS EMPTY!**
3. Study the drawing below and those on pages 8 and 19. Use a screwdriver whose tip correctly fits the screw slot.
4. Remove the forearm by unscrewing the forearm takedown screw and gently pulling the forearm away from the receiver.
5. With hammer cocked, insert a “slave pin” through hole in hammer strut.
6. Pull trigger to release hammer spring tension.
7. Remove the hammer spring and strut as an assembly.
8. Lower the lever, unscrew lever pivot screw and lever pivot pin.
9. Remove hammer.
10. Raise lever to close breech, then lower lever about halfway and pull downward, removing the breech block, breech block arm and the linkage as a unit from the bottom of the receiver.
11. Remove the ejector, ejector plunger, and ejector plunger spring.

This is the extent of disassembly required for routine inspection, cleaning and lubrication. Further disassembly is not recommended!

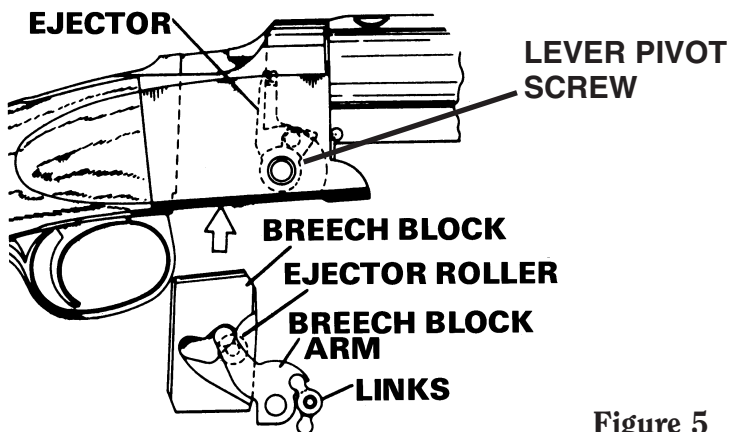

Figure 5

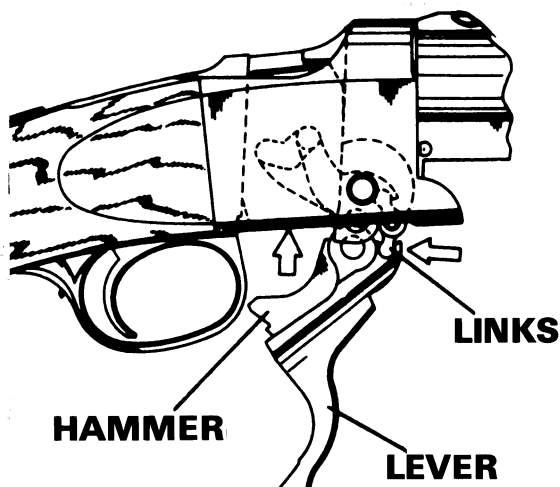

Figure 6

REASSEMBLY

1. Reassemble ejector, ejector plunger and spring in receiver.
2. Assemble breech block, breech block arm, ejector roller and linkage as shown in Figure 5, page 18 and replace as a unit into receiver while holding the ejector against the inside receiver wall.
3. Position hammer in the lever and engage the lever and link as shown in Figure 6, above.
4. Hold the ejector against the inside receiver wall and insert the lever into the receiver.
5. Move the lever to its closed position while depressing the trigger.
6. Replace pivot pin and retaining screw.
7. Replace hammer spring and strut assembly, cock the hammer and remove slave pin.
8. Reassemble forearm to receiver and tighten forearm takedown screw.
9. **With the rifle pointed in a safe direction**, check operation of lever, breech block, trigger and safety.

REGARDING ACCURACY: The accuracy of any rifle can vary depending upon the make and type of cartridges used in it. Such being the case, if your **RUGER® NO. 1** rifle does not perform to expectations, it is advisable to try several brands and types of cartridges to determine which one delivers the best accuracy, before proceeding further. If your rifle is not as “accurate” as you believe it should be, before concluding that some serious fault exists, run the following checks:

1. Be certain the forend screw is snugly tightened.
2. Be certain the bore is clean and free from accumulated metal fouling (deposited by metal jacketed and lead bullets). See the “Care and Cleaning” section of this manual.

3. Check the sights for tightness, setting and alignment.
4. Rest the forend on your hand, not directly onto a rest. Never rest the barrel directly onto a rest.

If everything is tight, the bore is clean, the sights are properly aligned and secure but the accuracy problem persists, DO NOT alter the stock bedding in any way. Do not scrape away wood and do not bed with “glass,” plastic, epoxy, etc. Once a rifle stock has been altered, it cannot be reworked by our Product Service Department.

If you still have an accuracy problem, write a brief letter to our Product Service Department in Newport, New Hampshire 03773 and describe the nature of the problem based on the use of factory-loaded cartridges – not reloads. You will receive a prompt response from us and if indicated, detailed instructions with regard to the return of the rifle.

CARE AND CLEANING





WARNING: BEFORE CLEANING, BE CERTAIN THE RIFLE CONTAINS NO CARTRIDGES.

A firearm must be free of rust, dirt, grease and firing residues to function safely and reliably. Periodic maintenance, which includes inspection of components to determine if they are in proper working order, is absolutely essential. Firing deposits particles of bullet lubricant and powder in the bore, chamber, receiver and other parts of the rifle. There is no fixed rule as to how frequently the cleaning should be carried out, but the alert gun owner soon learns that any firearm functions most reliably and accurately when it is free of accumulations of grease and other firing residues.

Basic cleaning equipment includes: A correct size cleaning rod equipped with bore brushes (fiber and brass) and a tip in which a cloth patch can be inserted, patches, powder solvent, lubricant, small lint-free cloths and a toothbrush. Use correct size patches and brushes. Larger sizes will bind in the bore and can be very difficult to remove! Insert rod from the chamber end of the barrel and push firmly so the patch or brush emerges from the muzzle. Don't reverse the rod when a brush or patch is being used – it may bind. Don't use patches or brushes dripping with solvent or oil. Use rod and brushes with care so as not to damage gun.

1. To clean the rifle thoroughly, disassemble to the extent described above, taking care to put pins, screws and similar easily mislaid and 'rolling' components in a tray or box.
2. Push-pull a solvent-wetted patch through the bore several times. Next, using a solvent-wetted brush, run it the full length of the bore as many times as is necessary to completely remove all foreign matter from the bore and chamber. Dry the bore with clean patches and examine it. If bore remains fouled, repeat the brushing. Complete the cleaning by dry-patch wiping of bore and chamber.

3. Use a clean, solvent-wetted patch to remove firing residue and dirt from all “reachable” surfaces inside the receiver. Use the solvent-wetted toothbrush to dislodge caked dirt from components and from surfaces inside the receiver that can’t be reached with a patch. Use cleaning patches or the cloth to remove the solvent.
4. Wipe all surfaces – internal and external – with a very light coat of oil. Oil and similar preparations “collect” dirt particles which can interfere with reliable functioning of the rifle. Therefore, use these preparations very sparingly. A drop of oil applied to the breech block assembly components, the pivot points of the trigger mechanism, the safety, the lever, and the latch, will work into all the parts that need lubrication.
5. Reassemble the rifle and carefully wipe all solvent, lubricating and preservative preparations from the stock.

 WARNING – LUBRICATION	
	<p>Firing a rifle with oil, grease, or any other material even partially obstructing the bore may result in damage to the rifle and serious injury to the shooter and those nearby. Do not spray or apply lubricants directly on ammunition. If the powder charge of a cartridge is affected by the lubricant, it may not be ignited, but the energy from the primer may be sufficient to push the bullet into the bore where it may become lodged. Firing a subsequent bullet onto the obstructed bore may damage the rifle and cause serious injury or death to the shooter and those nearby. Use lubricants properly. You are responsible for the proper care and maintenance of your firearm.</p>
IMPROPER LUBRICATION DESTROYS GUNS	

6. If the rifle is to be stored for an extended period, clean the rifle thoroughly. Disassemble to the extent described elsewhere in this manual, taking care to put pins and similar easily mislaid and “rolling” components in a tray. Rewipe all surfaces with preservative oil. Reassemble and store properly.

STORAGE

GUNS SHOULD NOT BE STORED LOADED!

**USE THE LOCKING DEVICE SUPPLIED WITH THE RIFLE FOR STORAGE.
(SEE PAGE 5)**

Do not store the rifle in a leather case. Leather, and many cloth cases, attract moisture even though they may appear to be perfectly dry.

TO RENDER THE RIFLE INOPERATIVE FOR SAFE STORAGE

With the muzzle pointed in a safe direction, open the action and check the chamber to be sure the rifle is completely unloaded! Remove the forend screw. Carefully remove the forend and forend takedown nut. Open the lever and insert

a pin through the hole in the front of the hammer spring strut. With the muzzle pointed in a safe direction, pull the trigger and then remove the hammer spring assembly toward the front of the rifle. Now open the action and unscrew and remove the lever pivot screw on the left side of the receiver. The hammer can be removed from the bottom of the receiver. Replace the lever pivot screw, the forend nut, the forend, and the forend screw.

Store the hammer spring assembly and the hammer in different locations. When disassembled in this manner, the rifle is inoperable. It is impossible to fire the rifle until the hammer spring assembly and hammer have been correctly replaced into the rifle.

To reassemble the rifle for firing, remove the forend screw, the forend, and the forend takedown nut. Unscrew and remove the lever pivot screw. Reinsert the hammer into the receiver and secure it with the lever pivot screw. Replace the hammer spring assembly with the down-turned rear end of the strut facing downward. Replace the forend nut, remove the pin from the front of the hammer spring assembly. Replace the forend and tighten the forend screw. Check to be sure that the lever, hammer, trigger, and safety mechanisms work fully and freely. The rifle is now reassembled and can be loaded and fired normally.

While the rifle is less likely to be used by unauthorized persons when disassembled in the above manner, it is always safest to store a firearm with the supplied locking device correctly installed, or to store the firearm in a gun safe or other secure location, away from children and unauthorized adults. Guns should always be stored securely, unloaded and separate from their ammunition.

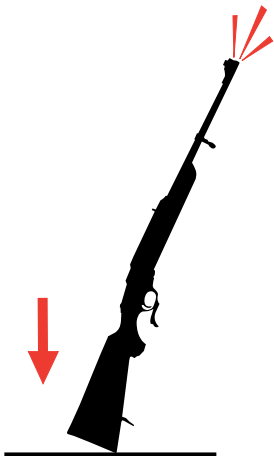
 WARNING – STORAGE	
	<p>Never place or store any firearm in such a manner that it may be dislodged. Firearms should always be stored securely and unloaded, away from children and careless adults. Use the locking device originally supplied with this firearm for storage.</p> <p>The use of a locking device or safety lock is only one aspect of responsible firearms storage. For increased safety, firearms should be stored unloaded and locked in a location that is both separate from their ammunition and inaccessible to children and any other unauthorized person.</p>
STORE SECURELY & UNLOADED	

QUICK DETACHABLE SLING SWIVEL

1. When attaching any QD swivel to its base, make sure the rotating gate is FULLY ENGAGED on the pin and there is no gap between the rotating gate and the swivel body. (See illustration below). A QD SWIVEL NOT ENGAGED CAN ACCIDENTALLY BECOME DETACHED FROM ITS BASE.

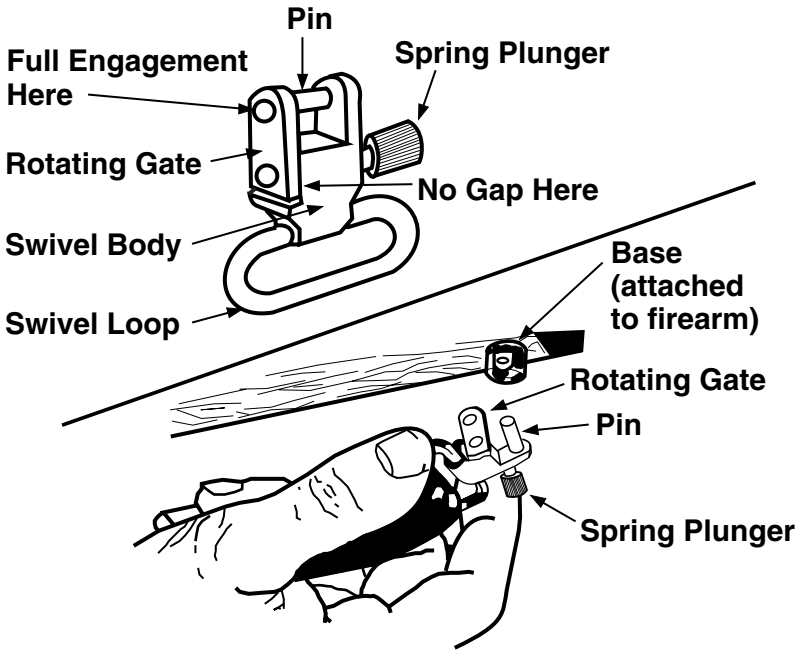

To Attach Swivel To Base:

- a. Press plunger.
 - b. Rotate gate.
 - c. Insert pin into base.
 - d. Rotate gate until pin enters hole in gate, then release plunger.
 - e. Make sure spring plunger fully engages pin, leaving no gap between gate and swivel body.
 - f. To detach swivel, reverse the above procedure.
2. Each time you use your rifle with a sling, be sure the QD swivel is fully engaged. Also, be sure to check the swivel periodically in the field to make certain it is fully engaged.
 3. Brush, tree limbs or other obstructions can pull at the swivel, sling, carry strap, scope or the firearm itself. If this happens, always check the swivel IMMEDIATELY to be sure it is fully engaged.

4. NEVER CLIMB OVER A FENCE, JUMP A DITCH, SCALE STEEP HILLS OR ROCKS, OR CLIMB A TREE OR TREE STAND WITH A LOADED FIREARM. PRACTICE THE RULES OF FIREARM AND HUNTING SAFETY.

(See pp. 35 - 38)

Failure to follow these safety rules could result in a swivel accidentally becoming detached from its base. If this happens, the firearm could fall, causing damage to the firearm or scope, and even accidentally discharge resulting in injury or death to yourself or others.

ATTACHING RUGER SCOPE RINGS

Each Ruger telescope ring is a mated assembly of a top and a base. Do not mix the parts of the two ring assemblies as they are not interchangeable. On the underside of each mounting ring assembly there is an integral lug, located off center with respect to the front and back sides of the mount. The lug is nearer to the front surface. By reference to the lug, the mounting ring can be correctly assembled with the front of the ring toward the muzzle of the rifle.

1. Disassemble one ring and reassemble over the scope body between the turret and the eyepiece. Remember - the lug on the base should be on the front side of the scope.
2. Install the four top screws. Do not tighten.
3. Disassemble the other ring and install it on the forward section of the scope tube with the lug forwardly also. Install the four top screws. Again, do not tighten.
4. Assemble the rings to the receiver with the lugs engaging the recesses in the top surface of the receiver. Tighten the clamp nuts so that the rings are locked to the semicircular cuts on the sides of the receiver.
5. Rotate the scope until cross-hairs are aligned properly and slide scope to desired eye relief. Then tighten the eight top screws each a bit at a time to grip the scope body.
6. Sight in according to the directions with your scope.

SIGHT ADJUSTMENT

(For Standard Rifles Equipped With Open Sights)

The folding leaf rear sight is adjustable for elevation. The slide must be moved one graduation to change the point of impact by approximately one inch at 25 yards. Shooting to determine the slide setting for 'zero' at a particular distance should be done from a bench rest and over a measured distance. Use only a small screwdriver with a blade tip that exactly fits the screw-head. Loosen the screws only slightly so the slide doesn't move too freely. Move the slide in the direction you want the point of impact of the bullet to move. When the slide is positioned at the desired height, carefully tighten both screws.

Lateral (windage) adjustment is made by "drifting" the sight base in its slot. Place a short brass rod against the sight base (and only the base) and tap the sight in the direction you wish to move the point of impact.

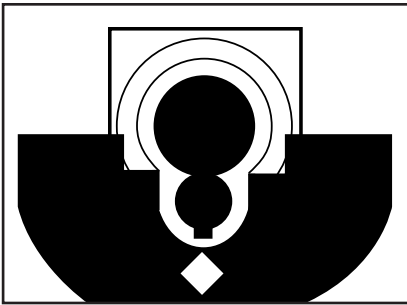

SUGGESTED SIGHT PICTURE

Top of front sight even with top of rear sight slide. Front sight centered in notch of rear sight slide. Target bull's-eye centered on top of front sight.

SERVICE AND PARTS POLICY

If you have any question with regard to the performance of your **RUGER® NO. 1** rifle please write or call (603-865-2442) our Product Service Department in Newport, New Hampshire 03773, fully describing all circumstances and conditions involved. If you should return your rifle to the factory for repair, or order parts for it, please comply with the following suggestions for prompt service:



WARNING: BEFORE SHIPPING ANY FIREARM, BE ABSOLUTELY CERTAIN THAT IT IS UNLOADED. DO NOT SHIP CARTRIDGES WITH A FIREARM.

SHIPPING FIREARMS FOR REPAIR

RUGER NO. 1 rifles returned to the factory for repair should be sent to: Sturm Ruger & Company, Inc., Product Service Department, Newport, New Hampshire 03773. Telephone (603) 865-2442.

Guns should be sent prepaid. We will not accept collect shipments.

The Federal Gun Control Act, as well as the laws of most States and localities, do not prohibit an individual (who is not otherwise barred from purchasing or possessing a firearm) from shipping a firearm directly to the manufacturer for repair. However, before you ship your rifle to us, be certain that your State or locality does not have a law or regulation which will prohibit you from receiving the rifle from us after it has been repaired. If such receiving is prohibited, then please have a Federally Licensed firearms dealer ship the gun to us. If your rifle is sent to us by a dealer, it will be returned to him after being repaired. If a handgun (pistol or revolver) is shipped by an individual who does not hold a Federal Firearms License, it must be shipped via U.P.S. (Next Day Air). Persons who do not hold a Federal Firearms License are prohibited by Federal law from shipping a handgun by Mail. Handguns mailed in violation of the law are impounded by the Post Office.

DO NOT SEND GUN BOXES OR LITERATURE THAT YOU CONSIDER TO BE COLLECTOR'S ITEMS – THESE ARE INVARIABLY DAMAGED OR DESTROYED IN SHIPMENT. Please do not include rifle case, sling, telescopic sights or custom accessories with a firearm being shipped to the factory for service. Rifles and shotguns may be shipped via Parcel Post. Always insure your shipment.

Enclose a letter which includes your name, address, telephone number, serial number and model of the firearm. Describe in detail the trouble you have experienced with your firearm, or the work you wish to have done. Merely stating that the firearm "needs repair" is inadequate information.

Work performed will bear a net minimum labor charge of \$20.00 plus a \$12.00 shipping and handling charge. The charge for rebluing the Ruger No. 1 rifle is \$50.00 plus a \$12.00 shipping and handling charge. Custom gunsmithing service for nonstandard alterations are **NOT AVAILABLE** from Ruger Product Service Departments.

We cannot fit wood to Ruger No. 1 rifles originally sold as barreled actions.



WARNING – PARTS PURCHASERS



It is the purchaser's responsibility to be absolutely certain that any parts ordered from the factory are correctly fitted and installed. Firearms are complicated mechanisms and **IMPROPER FITTING OF PARTS MAY RESULT IN A DANGEROUS MALFUNCTION, DAMAGE TO THE FIREARM, AND SERIOUS INJURY TO THE SHOOTER AND OTHER PERSONS.** The purchaser and installer of parts must accept full responsibility for the correct adjustment and functioning of the rifle after such installation.

PARTS MUST FIT CORRECTLY

ORDERING PARTS

Please contact the New Hampshire Product Service Department for parts availability and current prices. All parts orders for the **RUGER® NO. 1** should be sent to: Sturm, Ruger & Co., Inc., Product Service Department, 411 Sunapee Street, Newport, New Hampshire, 03773, (603) 865-2442.

We cannot comply with open account or C.O.D. requests. Payment in the form of a check, money order, Visa or Mastercard must accompany your order. Credit Card orders must include the account number, expiration date and whether it is a Visa or Mastercard account. Minimum parts order is \$1.00 plus a \$3.50 shipping and handling charge. Order parts by Part Number and Part Name and include the entire serial number of the firearm for which the parts are being ordered. There is a minimum net labor charge of \$20.00 plus \$12.00 shipping and handling if the parts are factory fitted. All factory-fitted parts are fitted on an exchange basis only. We will not return the replaced parts.

Because the receiver of the Ruger No. 1 rifle is a serial numbered component, it is defined as a "firearm" by Federal law and is not sold as a separate component.

*Parts designated by an asterisk must be factory fitted. These parts are fitted on an exchange basis only. We will not return the replaced parts. We will not return any part that is broken, malfunctioning, badly worn or has been modified. See "Warning — Parts Purchasers", above.



CAUTION: Firearm users are cautioned that a gun containing modified, broken, malfunctioning, or badly worn parts should not be fired.

RUGER® NO. 1 RIFLE

PARTS LIST

Design, prices and specifications subject to change without notice.

SPECIFY MODEL AND CALIBER WHEN ORDERING

(See Exploded Views on Page 34)

Part Name	Part No.	Model
** Barrel, Specify Model, Caliber & Barrel Length	_____	All Blued or Stainless Models
Barrel Rib, with Dovetail Specify Model & Caliber	S-135	Standard, Light Sporter, Medium Sporter, Tropical, International - Blued Models
Barrel Rib, with Dovetail Specify Model & Caliber	KS-132	Tropical - Stainless Models
Barrel Rib, with Dovetail Specify Model & Caliber	KS-135	Medium Sporter - Stainless Model
Barrel Rib, without Dovetail Specify Model & Caliber	S-130	Standard, Light Sporter, Medium Sporter, Tropical, International - Blued Models
Barrel Rib, without Dovetail Specify Model & Caliber	KS-130	Standard - Stainless Models
Barrel Rib Dowel, Front	S-151	Light Sporter, Medium Sporter, Tropical, International
Barrel Rib Dowel, Front	S-152	Standard - Blued Models
Barrel Rib Dowel, Front	KS-152	Standard, Medium Sporter, Tropical - Stainless Models
Barrel Rib Dowel, Front	S15101	Medium Sporter (.45-70 caliber only)
Barrel Rib Dowel, Rear	S-151	Standard, Light Sporter, Medium Sporter, Tropical (.375 cal. only), International - Blued Models
Barrel Rib Dowel, Rear	KS-151	Standard, Medium Sporter, Tropical - Stainless Models
Barrel Rib Dowel, Rear	S-152	Tropical
Barrel Rib Screws, Front (2 Req'd.)	S-139	Light Sporter, International

**These parts are factory fitted on an exchange basis only. We will not return the replaced parts. Please contact the New Hampshire Product Service Department at (603) 865-2442 for the correct part number.

Part Name	Part No.	Model
Barrel Rib Screws, Front (2 Req'd.)	S-138	Standard, Medium Sporter, Tropical - Blued Models
Barrel Rib Screws, Front (2 Req'd.)	KS-137	Medium Sporter - Stainless Model
Barrel Rib Screws, Front (2 Req'd.)	KS-138	Standard, Tropical - Stainless Models
Barrel Rib Screws, Rear (2 Req'd.)	D06101	Standard, Light Sporter, Medium Sporter, International - Blued Models
Barrel Rib Screws, Rear (2 Req'd.)	KD06101	Standard - Stainless Models
Barrel Rib Screws, Rear (2 Req'd.)	S-137	Tropical (.375 cal. only)
Barrel Rib Screws, Rear (2 Req'd.)	KS-137	Medium Sporter, Tropical - Stainless Models
Barrel Rib Screws, Rear (2 Req'd.)	S-138	Tropical
* Breech Block	S-10	All Blued Models
* Breech Block	KS-10	All Stainless Models
* Breech Block Arm	S-9	All Models
* Breech Block Assembly	A-214	All Blued Models
* Breech Block Assembly	KA-214	All Stainless Models
Ejector, Specify Model & Caliber	S-125	All Blued Models
Ejector, Specify Model & Caliber	KS-126	All Stainless Models
Ejector Cam	S-13	All Models
Ejector Cam Pivot Pin	S-45	All Models
Ejector Plunger	S-29	All Models
Ejector Plunger Spring	S-30	All Models
Ejector Roller	S-27	All Models
Ejector Strut	S-46	All Models
Ejector Strut Adjustment Screw	S-49	All Models
Ejector Strut Spring	S-48	All Models
Ejector Strut Swivel	S-47	All Models
* Firing Pin	S-11	All Models
* Firing Pin Spring	KE-48	All Models
* Forearm, With Escutcheon, Alexander Henry	70060	Light Sporter
* Forearm, With Escutcheon, Alexander Henry	70058	Tropical (.375 cal. only) - Blued Model
* Forearm, With Escutcheon, Alexander Henry	70057	Tropical - Blued Models
* Forearm, With Escutcheon, Alexander Henry, Laminated	70063	Tropical - Stainless Models

Part Name	Part No.	Model
* Forearm, With Escutcheon, Alexander Henry	70059	Medium Sporter - Blued Models
* Forearm, With Escutcheon, Alexander Henry, Laminated	70064	Medium Sporter - Stainless Model
* Forearm, With Escutcheon, International	70054	International
* Forearm, With Escutcheon, Semi-Beavertail	70056	Standard - Blued Models
* Forearm, With Escutcheon, Beavertail	70062	Standard - Stainless Models
* Forearm, With Escutcheon, Semi-Beavertail	70055	Varminter - Blued Models
* Forearm, With Escutcheon, Beavertail	70061	Varminter - Stainless Model
Forearm Escutcheon	S-50	All Models
Forearm Take Down Nut	S-88	All Models
Forearm Take Down Screw	S-51	All Models
Front Sight Base	S06505	Light Sporter, Medium Sporter, Tropical, International
Front Sight Base	KS06502	Tropical - Stainless Models
Front Sight Base	KS06504	Medium Sporter - Stainless Model
Front Sight Base Set Screw	D-70	Light Sporter, Medium Sporter, Tropical, International
Front Sight Blade Assembly	D06702A	Light Sporter, Medium Sporter, Tropical, International
Front Sight Plunger Spring	D-69	Light Sporter, Medium Sporter, Tropical, International
Front Sight Retaining Plunger	D-68	Light Sporter, Medium Sporter, Tropical, International
* Hammer	S-17	All Blued Models
* Hammer	KS-17	All Stainless Models
Hammer Spring	S-18	All Models
Hammer Spring Retaining Washer	S-59	All Models
Hammer Strut	S-25	All Models
Hammer Strut Assembly	A-212	All Models
Hammer Transfer Block	S-15	All Models
Hammer Transfer Block Pivot Pin	S-26	All Models
* Lever	S-6	All Blued Models & Standard (.25/06 cal. only) Stainless Model
* Lever	KS-6	Standard, Medium Sporter, Tropical, Varminter - Stainless
* Lever Assembly	S-6B	All Blued Models & Standard (.25/06 cal. only) Stainless Model
* Lever Assembly	KS-6B	Standard, Medium Sporter, Tropical, Varminter - Stainless
* Lever Latch	S-7	All Blued Models & Standard (.25/06 cal. only) Stainless Model

Part Name	Part No.	Model
* Lever Latch	KS-7	Standard, Medium Sporter, Tropical, Varminter - Stainless
Lever Latch Pivot Pin	S-40	All Blued Models & Standard (.25/06 cal. only) Stainless Model
Lever Latch Pivot Pin	KS-40	Standard, Medium Sporter, Tropical, Varminter - Stainless
Lever Latch Spring	S-41	All Models
Lever Link and Pin Assembly	A-206	All Models
Lever Pivot Pin	S-43	All Blued Models
Lever Pivot Pin	KS-43	All Stainless Models
Lever Pivot Screw	S-44	All Blued Models
Lever Pivot Screw	KS-44	All Stainless Models
Muzzle Cap	S01341	International
Muzzle Cap Escutcheon	D13300	International
Muzzle Cap Screw	D13200	International
Pistol Grip Cap, Not Illustrated	S-97	All Blued Models
Pistol Grip Cap, Not Illustrated	KS-97	All Stainless Models
Pistol Grip Cap Medallion, Not Illustrated	S-61	All Models
Pistol Grip Cap Screw, Not Illustrated	S-36	All Models
Rear Sight	D-77	Light Sporter, Medium Sporter, Tropical, International
Receiver Filler Screws (2 Req'd), Not Illustrated	C-83	Varminter
Recoil Pad	D06304	All Models
Recoil Pad Screws, (2 Req'd.)	D-84	All Models
* Safety	SC-52	All Blued Models
* Safety	KSC-52	All Stainless Models
Safety Arm	S-16	All Models
Safety Arm Pivot Pin	S-32	All Models
Safety Bar	S-22	All Models
Safety Bar Arm Assembly	S-22A	All Models
Safety Bar Pivot Pin	S-58	All Models
Safety Detent Spring	S-54	All Models
Safety Detent Spring Pin	S-39	All Models
Safety Retaining Pin, (2 Req'd.)	S-31	All Models

Part Name	Part No.	Model
Scope Base, Not Illustrated	SC-24VA-A	Varminter - Blued Models
Scope Base, Rear, Not Illustrated	KSC-132	Varminter - Stainless Model
Scope Base Screws (4 Req'd), Not Illustrated	B-89	Varminter - Blued Models
Scope Base Screws (4 Req'd), Not Illustrated	KB-89	Varminter - Stainless Model
Scope Ring Clamp, Not Illustrated	D-74	All Blued Models
Scope Ring Clamp, Not Illustrated, Matte	KD-74M	All Stainless Models
Scope Ring Nut, Not Illustrated	D-73	All Blued Models
Scope Ring Nut, Not Illustrated, Matte	KD-73M	All Stainless Models
Scope Base Torx® Head Screw, (8 Req'd.)	MPF07600	All Blued Models
Scope Base Torx® Head Screw, (8 Req'd.)	KMPF07600M	All Stainless Models
Scope Rings, medium rings, Not Illustrated	S-100RM	Blued Models
Scope Rings, medium rings, Not Illustrated	KS-100RM	Stainless Models
Scope Rings, high rings, Not Illustrated	KS-100RH	Stainless Models
Sear Adjustment Screw	S-56	All Models
* Sear & Trigger Assembly (Includes Sear, Sear Link & Sear Link Pin)	A-256	All Blued Models
* Sear & Trigger Assembly, Clear Coated (Includes Sear, Sear Link & Sear Link Pin)	KA-256	All Stainless Models
Sear Pivot Pin	S-33	All Models
Sear Spring	S-42	All Models
Sling Swivel	S-85B	All Models
Sling Swivel Band	S-142	Light Sporter
Sling Swivel Band	S-144	Tropical (.375 cal. only) - Blued Model
Sling Swivel Band	KS-144	Tropical (.375 cal. only) - Stainless Model
Sling Swivel Band	S-145	Tropical - Blued Models
Sling Swivel Band	KS-145	Tropical - Stainless Models
Sling Swivel Band	S-143	Medium Sporter - Blued Model
Sling Swivel Band	KS-143	Medium Sporter - Stainless Model
Sling Swivel Band Set Screw	D-70	Light Sporter, Medium Sporter, Tropical
Sling Swivel Escutcheon, (2 Req'd.)	D12900	International
Sling Swivel, Front	D13100	International

Part Name	Part No.	Model
Sling Swivel Mounting Screw, Rear	S-87	All Blued Models
Sling Swivel Mounting Screw, Rear	KS-87	All Stainless Models
Sling Swivel Nut, Front	S-86A	Standard, Varminter
Sling Swivel Screw	D13000	International
Sling Swivel Screw, Front	S-86B	Standard, Varminter - Blued Models
Sling Swivel Screw, Front	KS-86B	Standard, Varminter - Stainless Models
Stock Bolt	S-37	All Models
Stock Bolt Washer	S-38	All Models
* Stock, Butt, Complete With Cap & Pad	70052	All Blued Models
* Stock, Butt, Laminated, Complete With Cap & Pad	70053	All Stainless Models
† Torx [®] Key Wrench, Not Illustrated (for scope base Torx [®] Head Screw)	MPF07601	All Models
* Trigger	SC-20	All Blued Models
* Trigger, Clear Coated	KSC-20	All Stainless Models
* Trigger Assembly (Includes Trigger, Trigger Spring Adjustment Screw & Sear Adjustment Screw)	A-254	All Blued Models
* Trigger Assembly, Clear Coated (Includes Trigger, Trigger Spring Adjustment Screw & Sear Adjustment Screw)	KA-254	All Stainless Models
Trigger Adjustment Spring	S-53	All Models
* Trigger Guard	S-2	All Blued Models
* Trigger Guard	KS-2	All Stainless Models
Trigger Guard Retaining Pin, (2 Req'd.)	MS06600	All Models
Trigger Pivot Pin	S-33	All Models
Trigger Spring Adjustment Screw	S-34	All Models
Williams Gib Lock, Sight Clamp Rear, Not Illustrated	D-83	Light Sporter, Medium Sporter, Tropical, International
Williams Gib Lock Screw, Not Illustrated	D-64	Light Sporter, Medium Sporter, Tropical, International

* PARTS SO MARKED MUST BE FACTORY FITTED

† Contact the Newport, NH Product Service Department (603-865-2442) for price.

RUGER® NO. 1 RIFLE

EXPLODED VIEW

NOTE: Not all the components shown in this drawing are standard equipment on all models. Please see catalog to determine which type of sighting equipment, barrel rib, forearm, etc., is standard on a particular model.

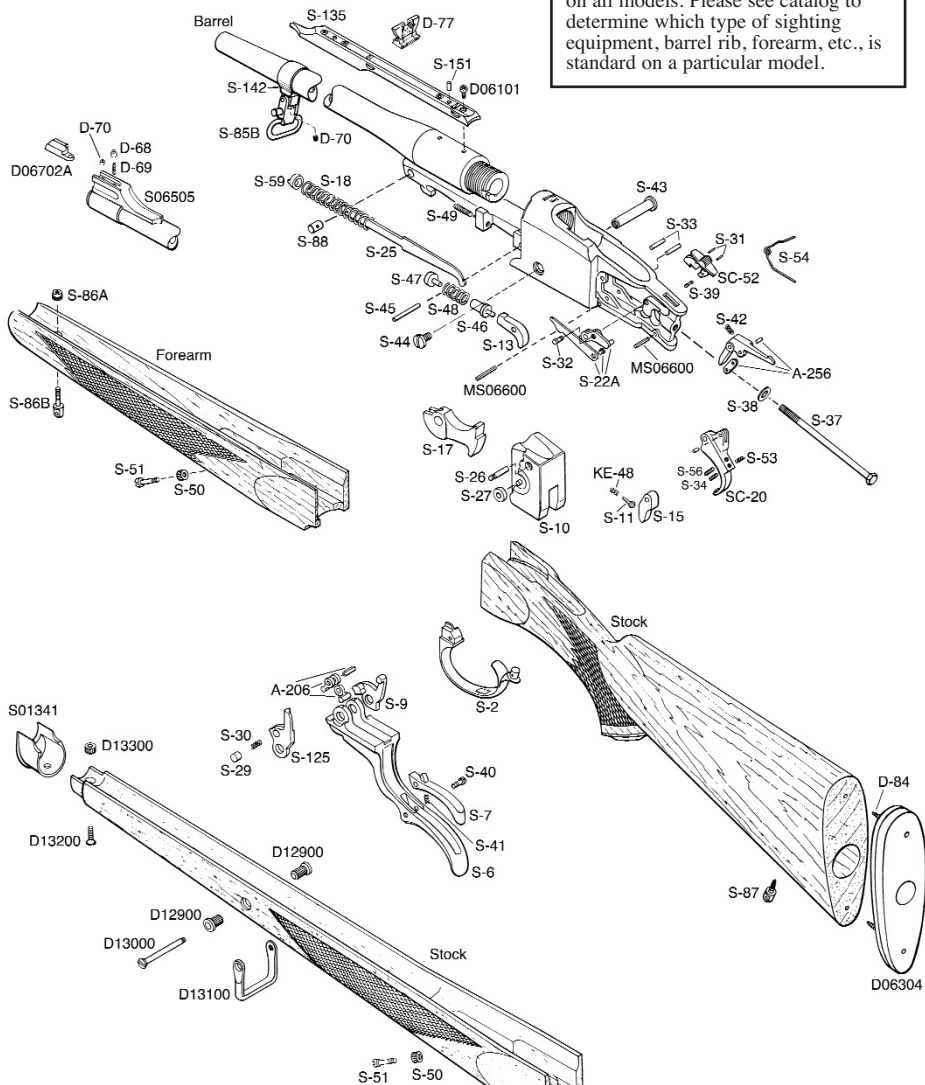

**INTERNATIONAL MODEL
COMPONENT PARTS**

THE BASIC RULES OF SAFE FIREARMS HANDLING

We believe that Americans have a right to purchase and use firearms for lawful purposes. The private ownership of firearms in America is traditional, but that ownership imposes the responsibility on the gun owner to use his firearms in a way which will ensure his own safety and that of others. When firearms are used in a safe and responsible manner, they are a great source of pleasure and satisfaction, and represent a fundamental part of our personal liberty.

Firearms do not cause accidents! Firearms accidents are almost always found to have been the result of carelessness, or ignorance on the part of the shooter of the basic rules of safe gun handling.

The following rules must be observed by gun users at all times. Safe gun handling is not just desirable, it is absolutely essential to your safety, the safety of others, and the continuation of gun ownership and sport shooting as we know it today.

1. LEARN THE MECHANICAL AND HANDLING CHARACTERISTICS OF THE FIREARM YOU ARE USING.

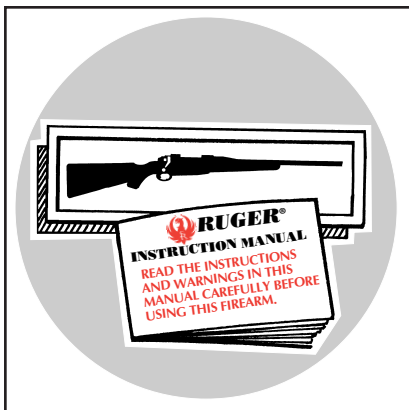

Not all firearms are the same. The method of carrying and handling firearms varies in accordance with the mechanical provisions for avoiding accidental discharge and the various proper procedures for loading and unloading. No person should handle any firearm without first having thoroughly familiarized himself with the particular type of firearm he is using, and with safe gun handling in general.

2. ALWAYS KEEP THE MUZZLE POINTED IN A SAFE DIRECTION.



Be sure of the bullet stop behind your target, even when dry-firing. Never let the muzzle of a firearm point at any part of your body or at another person. This is particularly important when loading or unloading a firearm. In the event of an accidental discharge, no injury can occur as long as the muzzle is pointing in a safe direction. A safe direction means a direction which will not permit a discharged bullet to strike a person, or to strike an object from which the bullet may ricochet.

A safe direction must take into account the fact that a bullet may penetrate a wall, ceiling, floor, window, etc., and strike a person or damage property. Make it a habit to know exactly where the muzzle of your gun is pointing whenever you handle it, and be sure that you are always in control of the direction in which the muzzle is pointing, even if you fall or stumble. Keep your finger off the trigger until you are ready to shoot.

3. FIREARMS SHOULD BE UNLOADED WHEN NOT IN USE.

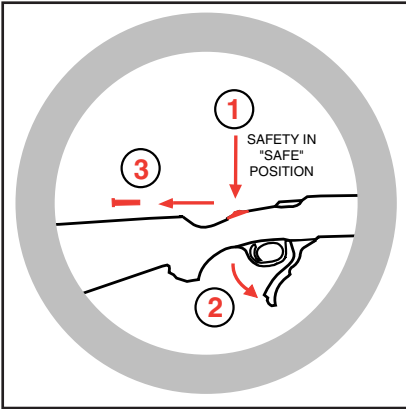

Firearms should be loaded only when you are in the field or on the target range or shooting area, ready to shoot. Firearms and ammunition should be securely locked in safes, racks or cabinets, or by using the locking device supplied with the firearm, when not in use. Ammunition should safely be stored separate from firearms. Store your firearms out of sight of visitors and children. It is the gun owner's responsibility to be certain that children and persons unfamiliar with firearms cannot gain access to firearms,

ammunition, or components.

4. BE SURE THE BARREL IS CLEAR OF OBSTRUCTIONS BEFORE SHOOTING.

Even a bit of mud, snow or excess lubricating oil or grease in the bore may cause the barrel to bulge, or even burst on firing, and can cause serious injury to the shooter and bystanders. Be sure that you are using ammunition of the proper caliber and loading for the gun you are using. If the report or recoil on firing seems weak, or doesn't seem quite right, **CEASE FIRING IMMEDIATELY**, unload your firearm, and check to be sure that no obstruction has become lodged in the barrel. Never try to shoot out an obstruction!

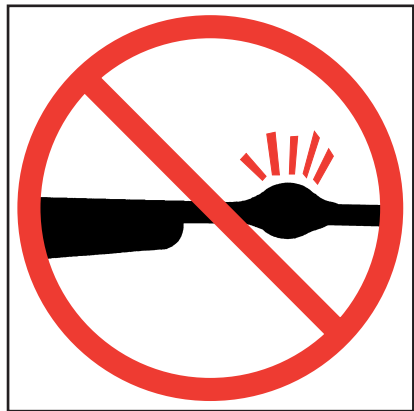



5. BE SURE OF YOUR TARGET BEFORE YOU SHOOT.

Don't shoot unless you know exactly where your bullet is going to strike. Be sure of the bullet stop behind your target, even when dry-firing with an unloaded gun. If you are in the field hunting, do not fire at a movement or noise. Take the time to be absolutely certain of your target before you pull the trigger.

6. WEAR SHOOTING GLASSES AND HEARING PROTECTORS WHEN YOU SHOOT.

All shooters should wear protective shooting glasses and adequate hearing protectors when shooting. Exposure to shooting noise can damage hearing, and adequate eye protection when shooting is essential.



7. NEVER CLIMB A TREE OR FENCE WITH A LOADED FIREARM.

Put the firearm down carefully before climbing a fence, and unload it before climbing or descending a tree or jumping over a ditch or other obstruction. Never pull or push a loaded firearm toward yourself or another person. When in doubt, or whenever you are about to do anything awkward, unload your gun!

8. DON'T SHOOT AT A HARD SURFACE, OR AT WATER.

Bullets can glance off many surfaces like rocks or the surface of water and travel in unpredictable directions with considerable velocity.

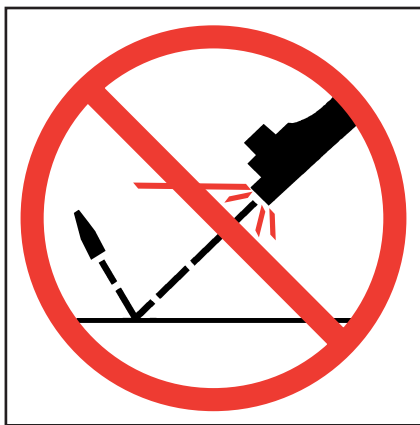

9. NEVER TRANSPORT A LOADED FIREARM.

Firearms should always be unloaded before being placed in a vehicle. A suitable carrying case or scabbard should be used to carry an unloaded firearm to and from the shooting area.

10. AVOID ALCOHOLIC BEVERAGES WHEN SHOOTING.

Don't drink until the day's shooting is over. Handling firearms while under the influence of alcohol in any form, or medications that could affect your judgement or co-ordination, constitutes a criminal disregard for the safety of others.



A BRIEF ACCOUNT OF AN EXTRAORDINARY ACHIEVEMENT: RUGER FIREARMS

One of the few American firearms manufacturers whose management has remained unchanged since starting in business, Sturm, Ruger & Company, Inc., had its beginning in a small machine shop occupying a rented frame building in Southport, Connecticut. In January, 1949, with an initial investment of only \$50,000 and an idea, William B. Ruger and Alexander M. Sturm started production of a .22 caliber autoloading pistol – a design which was so successful that it became the cornerstone upon which one of the most comprehensive lines of sporting firearms ever made in America was established. After Alex Sturm's death in 1951, William B. Ruger continued to direct the company alone and today, as Chairman Emeritus of the Board, he continues to provide the guidance which has made this 52 year-old company a sound and successful enterprise.

Sturm, Ruger & Company, in this relatively short time, has established itself as a leading small arms design organization, developing a unique and broad line of fine quality sporting, military and police firearms to become one of the world's most famous producers of revolvers, pistols, rifles and shotguns. From 1949 thru 2001 Ruger craftsmen have built many millions of firearms.

During its five decades of growth and progress under the leadership of William B. Ruger, the company has developed a business philosophy and implemented policies which represent a constructive influence in the life of modern America. From the beginning, Sturm, Ruger & Company played a positive role in conservation efforts and has supported the interests of shooters through such groups as the National Rifle Association, National Shooting Sports Foundation, and many regional sportsmen's organizations. The company has always endeavored to market its firearms for constructive and recreational purposes, to emphasize the traditional aspects of shooting, to render meaningful public services and to encourage shooters in constructive, responsible, and safe participation in the shooting sports.

Today, Sturm, Ruger & Company is particularly mindful of those elements which have contributed to the creation of its success, and extends heartfelt thanks to its many loyal employees and customers.

A current catalog of Ruger firearms is available free upon request to
Sturm, Ruger & Co., Inc., Southport, CT 06490

WHY NO WARRANTY CARD HAS BEEN PACKED WITH THIS NEW RUGER FIREARM

The Magnuson-Moss Act (Public Law 93-637) does not require any seller or manufacturer of a consumer product to give a written warranty. It does provide that if a written warranty is given, it must be designated as "limited" or as "full" and sets minimum standards for a "full" warranty. Sturm, Ruger & Company, Inc. has elected not to provide any written warranty, either "limited" or "full", rather than to attempt to comply with the provisions of the Magnuson-Moss Act and the regulations issued thereunder. There are certain implied warranties under state law with respect to sales of consumer goods. As the extent and interpretation of these implied warranties varies from state to state, you should refer to your state statutes. Sturm, Ruger & Company wishes to assure its customers of its continued interest in providing service to owners of Ruger firearms.



STURM, RUGER & Company, Inc.
Southport, Connecticut 06490 U.S.A.
<http://www.ruger.com>

“Arms Makers For Responsible Citizens”

**A COPY OF THE INSTRUCTION MANUAL FOR ANY RUGER
FIREARM IS AVAILABLE FROM THE FACTORY FREE ON REQUEST.
THESE INSTRUCTION MANUALS CONTAIN IMPORTANT
WARNINGS WHICH MUST BE UNDERSTOOD
BEFORE USING THESE FIREARMS.**

“RUGER”, the Sturm, Ruger logo, “SINGLE-SIX”, “BLACKHAWK”, “REDHAWK”, “SECURITY-SIX”,
“SPEED-SIX”, “SERVICE-SIX”, “BEARCAT”, “OLD ARMY”, “10/22”, “MINI-14”, “MINI THIRTY”,
“RANCH RIFLE”, “M77”, “77/22”, “GP-100”, “SP101”, “P-85” and “VAQUERO”
are registered U.S. trademarks.
“77/50” is a Ruger trademark.