

Owner's Manual

Owner's Manual for:
Remington Model SPR 94
Over/Under Combination
Rifle/Shotgun .410 Ga/Rimfire

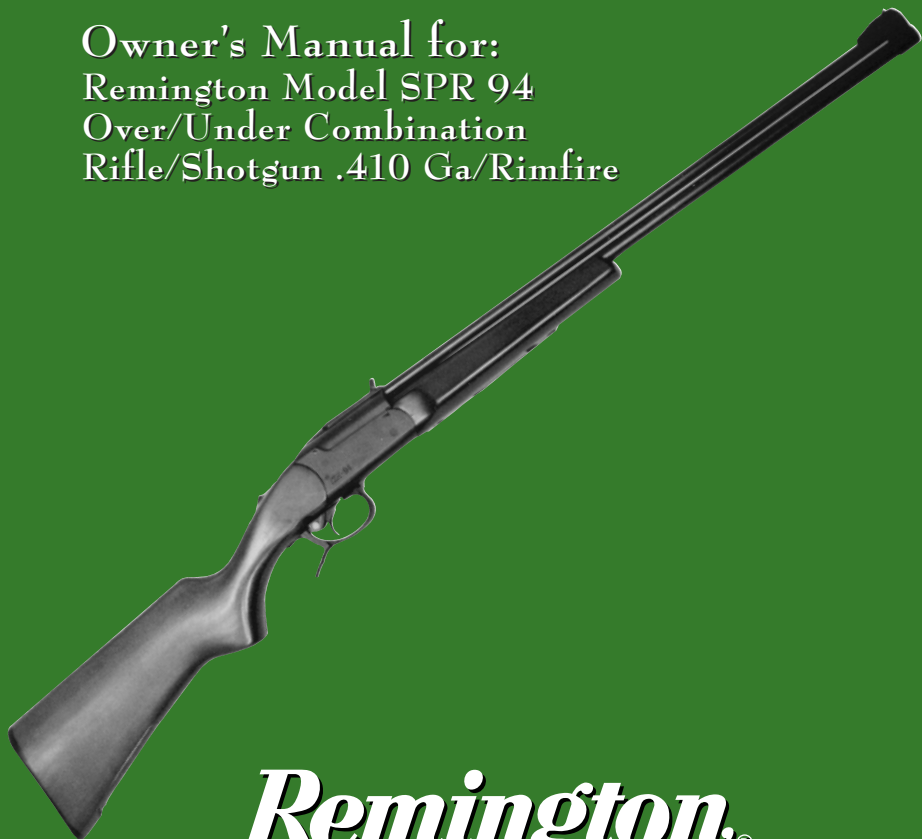

Remington®

IMPORTANT!

READ ALL WARNINGS AND
INSTRUCTIONS IN THIS
MANUAL BEFORE USING THIS SHOTGUN



PAGE 2THE TEN COMMANDMENTS OF FIREARM SAFETY

PAGE 7IMPORTANT PARTS OF THE FIREARM

PAGE 10.....ASSEMBLY INSTRUCTIONS

PAGE 12.....LOADING AND UNLOADING

PAGE 14FIRING

PAGE 15DISASSEMBLY INSTRUCTIONS

Safety is Critical to Performance.

A superbly crafted gun is only as good as the hands that hold it. You can never be too careful. Shooting accidents are often caused by careless oversights such as failing to control the direction of the muzzle, failing to fully engage the safety, leaving ammunition in the chamber or using improper loads. These oversights can result in the destruction of life, limb or property. There's no calling back a bullet once it's been fired, so it's critical that you know the principles of safe gun handling and storage before you ever take your new Remington firearm out of the box.

The proper use and performance of your firearm depends on correct assembly and maintenance, so it's critical that you familiarize yourself with the information in this instruction book. Even if you're a veteran shooter with a collection of Remington firearms, take the time to read this literature. Not all firearms are the same. That means the first step in safe handling is to learn the features and requirements of your new Remington.

THE TEN COMMANDMENTS OF FIREARM SAFETY

With the privilege of owning a firearm comes the responsibility to use it safely. You must understand and follow the Ten Commandments of Firearms Safety at all times. These time-honored safety rules apply to your ownership and handling of any firearm. They must govern your actions whenever and wherever you are involved with firearms . . . in the field, on the range, or in your home. Commit these Ten Commandments to your memory.

1st COMMANDMENT

Always Keep the Muzzle Pointed in a Safe Direction.

This is the most important gun safety rule. A safe direction is one in which an accidental discharge will not cause injury to yourself or others. Never allow your gun to point at anything you don't intend to shoot. Be especially careful when you're loading or unloading. Treat every gun as if it were loaded. And make it a habit to know where the muzzle is pointed at all times, even when your firearm is unloaded. No one will be injured by an accidental discharge if you keep your firearm pointed in a safe direction. It's as simple as that.

2nd COMMANDMENT

Firearms Should be Unloaded When Not in Use and Secured from Unauthorized Use.

Load your firearm only when you are in the field or on the range and ready to shoot. Unload your firearm as soon as you are finished shooting. Never bring a loaded firearm into your camp, home or vehicle. Unloading means unloading both the chamber and the magazine. Before handling a firearm or passing it on to someone else, visually check the chamber, receiver, and magazine to make sure there is no ammunition anywhere in the firearm. Never assume a firearm is unloaded, and never take someone's word for it - look for yourself. When you are finished shooting and have completely unloaded the firearm, leave its action open.

Whenever you are carrying a loaded firearm in the field, you must unload it before crossing a fence, climbing into a tree stand or blind or in any other situation where you may not be able to fully control the firearm. Never pull or push a loaded firearm toward yourself or another person.

Store your firearms unloaded in a secure place where unauthorized persons cannot gain access to them. Store firearms and ammunition separately. If you use an external security device such as a cable lock or trigger lock, you must still keep the firearm unloaded when locked. Whether you utilize a locked gun safe or external locking device, it is your responsibility to make sure that children and other unauthorized persons cannot gain access to your firearm and ammunition.

3rd COMMANDMENT

Never Rely on Your Firearm's Safety Mechanism to Justify Careless Handling.

If your firearm is equipped with a manual safety mechanism, do not rely on the safety as an excuse for improper or careless handling of the firearm. The safety mechanism is merely a supplement to your proper handling of the firearm. The safety mechanism may be broken or altered. Even if you think you have previously engaged the safety in the "safe" position, it may have been inadvertently disengaged without your knowledge while being carried. Never assume that the safety mechanism is engaged in the "safe" position. Your assumption may be wrong or mistaken. Treat your firearms safety mechanism like you would treat any other mechanical device - as something that could break or fail.

Not all safety mechanisms operate in the same manner. Before using any firearm, know and understand precisely how the safety mechanism on that particular firearm operates. Never pull the trigger when the safety mechanism is in the "safe" position, and keep your fingers away from the trigger while loading, unloading, and engaging or disengaging the safety mechanism.

4th COMMANDMENT

Know Your Target and What's Beyond It.

Never fire a shot unless you know exactly where the shot is going and what it will strike. Bullets and shot can travel great distances with deadly velocity. When hunting game, never fire at a sound, a movement or a patch of color - an impulsive shot can have tragic consequences. A fellow hunter in camouflage may be mistaken for game by an impulsive shooter.

In addition to being sure of your target, you must know what lies beyond the target. In other words, make sure of your backstop. Also, beware of ricochets - never shoot at water or a hard surface.

5th COMMANDMENT

Use Proper Ammunition.

Every firearm is designed to use only a specified caliber, gauge or length of ammunition. Use of the wrong ammunition can cause serious personal injury or death. It is your responsibility to make sure the ammunition exactly matches the specifications for your firearm.

Use of improperly reloaded ammunition can also be dangerous. Firearms are designed, manufactured, and proof-tested to specified industry standards. Hand-loaded or reloaded ammunition that deviates, either intentionally or accidentally, from specified loadings can be extremely hazardous. It is strongly recommended, therefore, that you use only factory ammunition from a reputable ammunition manufacturer. If you do reload, you have assumed the risks and responsibilities of an ammunition manufacturer.

6th COMMANDMENT

If Your Firearm Fails to Fire When You Pull the Trigger, Handle With Care.

If a chambered round of ammunition does not fire when you pull the trigger, stop and keep the muzzle pointed in a safe direction. Treat your firearm as if it could still discharge. Keep your face away from the breech. Slowly and carefully open the action, return the safety mechanism to the "safe" position, and unload the cartridge from the chamber. Dispose of the cartridge safely. If your firearm repeatedly fails to fire when you pull the trigger, take your firearm and ammunition to a competent gunsmith or return the firearm to the manufacturer for inspection.

7th COMMANDMENT

Always Wear Eye and Ear Protection.

Wear protective shooting glasses and hearing protection when shooting. Be sure to wear eye protection when disassembling or cleaning a firearm to protect your eyes from springs and other tensioned parts. Continued exposure to shooting noise can permanently damage your hearing.

8th COMMANDMENT

Be Sure the Barrel is Clear of Obstructions Before Shooting.

With your firearm completely unloaded, open the action and make sure there are no obstructions or debris in the barrel. Even a small obstruction such as snow or mud in the barrel can cause the barrel or receiver to burst when the next round is fired. Use a cleaning rod to remove obstructions and residues from the barrel. If the firing noise or recoil seems weak, stop and completely unload your firearm to check for obstructions before firing another shot. NEVER try to shoot out an obstruction by loading and firing another round of ammunition.

9th COMMANDMENT

Never Alter or Modify Your Firearm and Have it Cleaned and Serviced Regularly.

Your firearm has been carefully designed and manufactured to operate according to certain factory specifications. NEVER alter or modify your firearm, especially its trigger or safety mechanism, in any way. Such alterations or modifications can adversely affect the safe operation of your firearm, endangering you and those around you.

As with any mechanical device, the parts of a firearm are subject to wear or breakage. To assure optimum safety and performance, your firearm must be maintained and serviced on a regular basis. Only a competent gunsmith or a Remington Authorized Service Center should service or repair your firearm.

Proper cleaning and lubrication are also important to maintain the safe and proper functioning of your firearm. Follow the cleaning and lubrication instructions set forth in the owner's manual for your firearm. NEVER attempt to clean or lubricate a loaded firearm.

10th COMMANDMENT

Learn How Your Firearm Operates.

Not all firearms are alike. Before you use any firearm for the first time, you must become totally familiar with how that firearm operates. When you receive a new firearm, read and understand the owner's manual before assembling the firearm for the first time. If you acquire a used firearm, request an owner's manual and have the rifle inspected by a competent gunsmith to determine whether it is in good working order. If you do not have an owner's manual, contact the manufacturer to obtain one. If you are selling or trading your firearm to someone else, be sure to transfer the owner's manual to the new owner.

LEAD EXPOSURE WARNING

Discharging firearms in poorly ventilated areas, cleaning firearms or handling ammunition may result in exposure to lead, a substance known to cause birth defects, reproductive harm, cancer and other serious physical injury. Have adequate ventilation at all times. Wash hands thoroughly after exposure.

SHOOT SOBER!

Guns and alcohol or drugs don't mix. Never consume anything that would even mildly impair your judgement or physical coordination while handling a firearm.

WARNING

Failure to follow any of these safety rules may cause personal injury or death to the shooter or bystander and damage to property. Do not use a firearm until you fully understand and practice the Ten Commandments of Firearm Safety. If you have any questions about the safe use of a Remington firearm, write to us at Remington Arms Company, Inc., Consumer Service, P.O. Box 700, Madison, NC 27025-0700, or call us at 1-800-243-9700.

Use the Security Lock Provided with your Combination Rifle/Shotgun

This combination rifle/shotgun comes with a security lock to assist in protecting against unauthorized use. (See **Picture 1**). The combination rifle/shotgun must be unloaded when the security lock is in place on the combination rifle/shotgun.

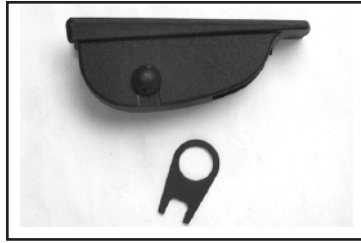

Picture 1

WARNING

Using the security lock cannot substitute for securing your firearm and ammunition in separate, locked locations.

The security lock operates as follows:

1. To open the Trigger Lock put the Key into the notches of the Trigger Lock Nut and un-screw it counter-clockwise (See **Pictures 2 and 3**). Remove the Trigger Lock Screw.

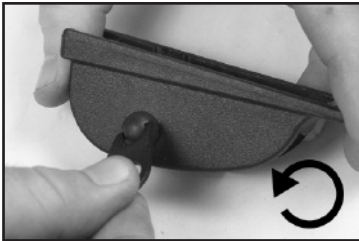

Picture 2

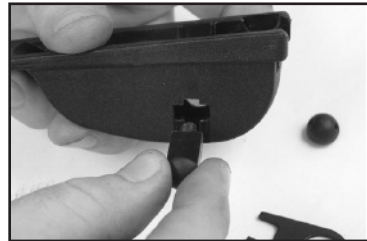

Picture 3

2. To install the Trigger Lock on a Combination rifle/shotgun put the Trigger Lock over the trigger guard with the larger end of the Trigger Lock shroud pointing toward the muzzle. Then place the Trigger Lock Screw through the cross-slotted hole on the side of the Trigger Lock Shroud. (See **Pictures 4 and 5**).

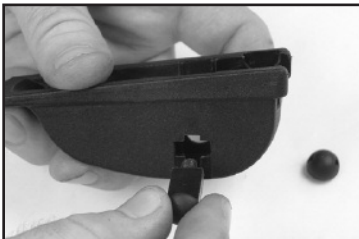

Picture 4



Picture 5

Use the Security Lock Provided with your Combination Rifle/Shotgun (cont'd)

3. Screw the Trigger Lock Nut on the Trigger Lock Screw (clockwise) and tighten the nut with the key. **DO NOT TIGHTEN THE NUT TOO TIGHT OR YOU COULD DAMAGE THE LOCK SCREW** (See **Picture 6**).



Picture 6

4. To remove the Trigger Lock, unscrew the Trigger Lock nut with the key and detach the Trigger Lock Screw (See **Picture 7**).



Picture 7

WARNING

Always store the key to the security lock: (1) in a separate location away from the shotgun; (2) in a secure location unknown and not accessible to others, especially children. Whether you secure your firearms by using the supplied security lock, a gun lock or a safe or some other mechanism, it is **YOUR RESPONSIBILITY** to store your firearms in such a manner that children and other unauthorized persons cannot gain access to them.

Important Parts of the Firearm

Congratulations on your choice of a Remington® Model SPR 94 Over and Under Combination Rifle/Shotgun (.410-Ga./Centerfire). With proper care and if used in accordance with the Ten Commandments of Firearm's Safety and this owner's manual, your shotgun should give you many years of dependable use and enjoyment. The following picture depicts the main parts of your shotgun and will aid in understanding the instructions in this Owner's Manual.

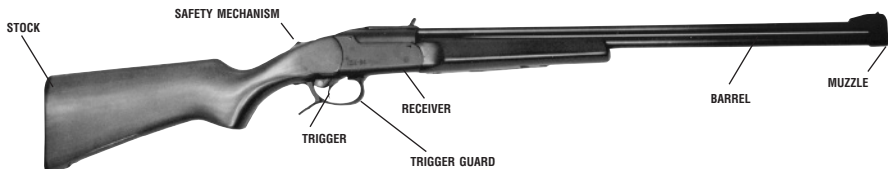

This picture shows the main parts of a Remington Model SPR94 Over and Under Combination rifle/shotgun. The picture will aid in understanding the instructions in this book.

External Control Parts

Trigger Block Safety: The safety mechanism of the Model SPR 94 is a cross-bolt style safety button located behind the trigger. To place the safety in the "ON" or "SAFE" position, the safety blocks the rearward motion of the trigger. (See **Picture 8**). To place the safety in the "OFF" or "FIRE" position, push the button all the way to the left. When in the "OFF" or "FIRE" position, a red ring is exposed on the left side of the safety button. You have now disengaged the safety, and the firearm is in a ready-to-fire condition. (See **Picture 9**).

The safety mechanism is a tang-style safety located behind the top lever. To place the safety in the "on" or "safe" position, pull the button all the way to the rear. (See **Picture 8**). When in the "on" or "safe" position, the safety blocks the rearward motion of the trigger(s). To place the safety in the "off" or "fire" position, push the slide button all the way forward. When in the "off" or "fire" position, a red dot is exposed behind the slide button. (See **Picture 9**). You have now disengaged the safety and combination rifle/shotgun is in the ready-to-fire condition.



Picture 8

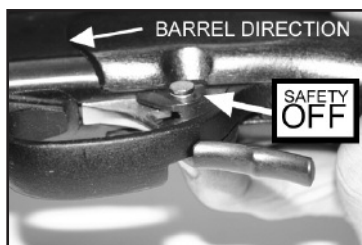

Picture 9

WARNING

Do not touch the trigger(s) while moving the safety. When operating the safety button, make sure you push or pull it to the full extent of its travel in the desired direction, either fully "on" or fully "off." Half-safe or partially safe is UNSAFE.

WARNING

The trigger block safety of the Model SPR 94 firearm provides protection against accidental or unintentional discharge under normal usage when properly engaged and in good working order. The safety mechanism is not a substitute for following the rules of safe gun handling.

External Control Parts (cont'd)

Locking Lever/Cocking Lever: The locking lever/cocking lever is located behind the trigger guard. (See **Picture 10**). The locking lever is used to break open the action to load and/or unload the shotgun. To break open the action, fully depress or squeeze the locking lever towards the stock. (See **Picture 11**). A partial squeeze/depressing of the lever can be used to decock or cock the firing mechanism.

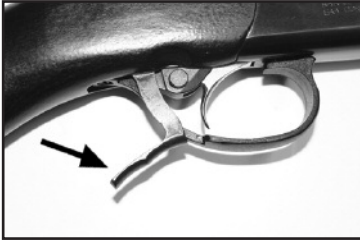

Picture 10

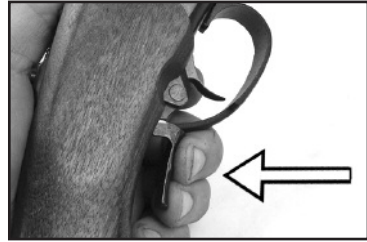

Picture 11



WARNING

When operating the locking lever, you must: (1) make sure the safety mechanism is in the "ON" or "SAFE" position; (2) keep your fingers away from the trigger and outside of the trigger guard, and (3) control the direction of the muzzle of the firearm.

Cocking Indicator: The cocking indicator is located on the top back portion of receiver. If the indicator is protruding out of the receiver, the firing mechanism is cocked. (See **Picture 12**). If the indicator is not protruding out of receiver, the firing mechanism is not cocked. (See **Picture 13**).

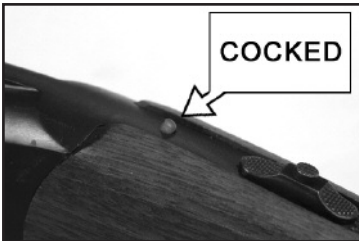

Picture 12

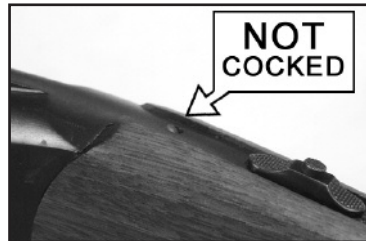

Picture 13



WARNING

The cocking indicator is merely an aid to help you confirm when hunting or shooting that your firearm is cocked and ready-to-fire. NEVER rely on the status of the cocking indicator to justify careless handling of your firearm. The cocking indicator may be broken or obscured. Always handle your firearm as if it were loaded, cocked and ready-to-fire.

Trigger: The trigger is located inside the trigger guard. (See **Picture 14**). If the safety is in the "OFF" or "FIRE" position, and hammer mechanism has been cocked and trigger is pulled to the rear, the firearm will discharge if there is a live cartridge in one of the chambers.

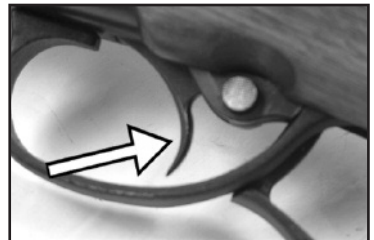

Picture 14



WARNING

Never pull the trigger until you are actually ready to fire. Keep your fingers off the trigger and outside of the trigger guard until you are ready to pull the trigger and fire the combination rifle/shotgun. When opening and closing the action and when engaging or disengaging the safety mechanism, make sure your fingers are outside the trigger guard and away from the trigger.

External Control Parts (cont'd)

Extractors: SPR 94 rifles are equipped with extractors for extracting the fired rounds when the action is opened. The extractor is located in the back center of the barrels. This is a single post extractor and will extract both rounds fired or unfired when the action is opened. (See **Pictures 15** and **16**).



Picture 15



Picture 16

Forend: The forend is the wooden grip piece that attaches to the barrel assembly and locks the barrel assembly into the receiver. (See **Picture 17**). The forend has a mechanical latch which is used to lock and unlock the forend to the barrel assembly. (See **Picture 18**). Never attempt to fire your combination rifle/shotgun without having the forend locked in its proper position on the barrel assembly.

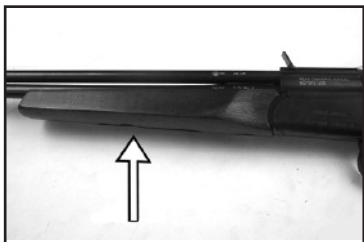

Picture 17

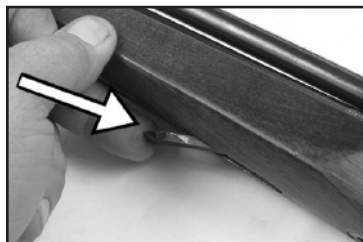

Picture 18

Barrel Selector: The barrel selector is located on the receiver tang. (See **Picture 19**). It is used to select which barrel will be fired when the trigger is pulled (Rifle or Shotgun). Push the button in the center and move it fore or aft to select which barrel/ammunition you wish to fire. Push the selector fully forward to select the rifle barrel for firing. (See **Picture 20**). Pull the selector fully rearward to select the shotgun barrel for firing. (See **Picture 21**). **MAKE SURE YOU UNDERSTAND HOW THE SELECTOR WORKS BEFORE YOU LOAD OR USE THE COMBINATION RIFLE/SHOTGUN.**

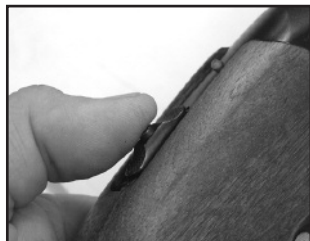

Picture 19



Picture 20



Picture 21

External Control Parts (cont'd)

Front Sight: Screws up and down for elevation. (See **Picture 22**).

Rear Sight: Windage adjustable. (See **Picture 23**).

Scope Mount Rail: 11mm rail. (See **Picture 24**).

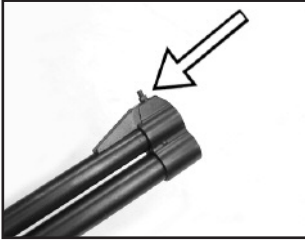

Picture 22

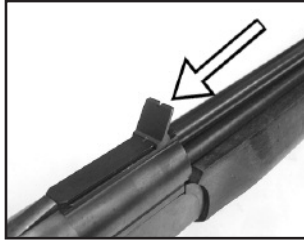

Picture 23

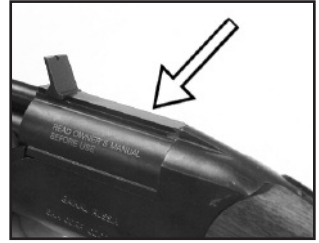

Picture 24

WARNING

Never adjust sights or scope mounting on a loaded firearm. The firearm should be completely unloaded before any such adjustments are made.

Instructions For Assembly Of Combination Rifle/Shotgun

WARNING

Before you begin to assemble the combination rifle/shotgun, you **MUST** (1) look down the barrels from the breech end toward the muzzle end to make sure there is no ammunition in the chambers or obstructions in the barrels, and (2) make sure the safety is in the "safe" position.

Your combination rifle/shotgun was shipped with the barrel assembly (barrels and forend) detached from the receiver assembly. To assemble the combination rifle/shotgun, follow these instructions:

1. Remove the plastic bags or wrapping covering the parts. Then remove the forend from the barrels by pulling outward on the mechanical lever in the lower midsection of the forend and tipping the forend out and away from the barrel. (See **Picture 25**).
2. Now fully squeeze/depress the locking lever and hold. (See **Picture 26**).



Picture 25

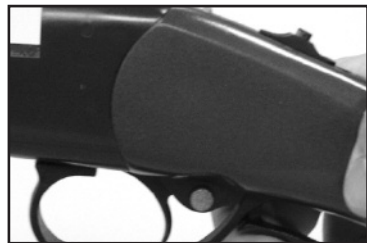

Picture 26

Instructions For Assembly Of Combination Rifle/Shotgun (cont'd)

3. Holding the barrel assembly with one hand, engage the lower locking lug located on the lower portion of the barrels with the receiver. The half round cut out on the lower locking lug fits around the round bar in the forward lower portion of the slot in the receiver. With the barrels engaged into the receiver, swing the barrels up into the locked position and release the locking lever which should move back to the fully locked position. (See **Picture 27**).



Picture 27

4. Now that the barrels have been locked into the receiver, you must reattach the forend to the barrels. Place the forend on the front curve of the receiver (the angle between the forend and barrels should be able 20 degrees). Keep contact between forend and receiver with an upward swinging motion and lock the forend into the barrels. (See **Picture 28**). While it may be necessary to push the latch into its final flat position, never force the latch into position.



Picture 28

5. Make sure the trigger block safety is in the "ON" or "SAFE" position after completion of assembly. (See **Picture 29**).



Picture 29

Loading and Unloading Your Combination Rifle/Shotgun

WARNING

Make sure the combination rifle/shotgun is pointed in a safe direction and the trigger block safety is engaged at all times while loading and unloading. NEVER allow your fingers or other objects to contact the trigger while loading or unloading. (See **Picture 30**).



Picture 30

WARNING

Do not disengage the trigger block safety until you are ready to fire and have the gun pointed safely downrange.

TO LOAD:

WARNING

Do not load the firearm until you are ready to fire.

1. Make sure the ammunition that you are using is the correct size and gauge/caliber. The top barrel is marked with the rifle caliber for the top barrel and with the gauge and chamber length for the lower barrel. Note: A shotgun barrel with a 3" chamber length will also use 2 ³/₄" shot shells. A shotgun barrel marked with 2 ³/₄" chamber length will not accept a 3" shotshell.
2. Visually inspect the chambers and barrels for obstructions by breaking open the combination rifle/shotgun by depressing the locking lever and tipping the barrels down. The chambers and barrels should be free of oil or grease or obstructions. (See **Picture 31**).



Picture 31

3. After inspection, load the correct type of shot shell into the bottom chamber and the correct type of rimfire cartridge into the top chamber. Make sure that the shell and cartridge are flush with the extractor. (See **Picture 32**). Then close the action by swinging the barrels up until they lock into the receiver. The locking lever should move to its fully locked position. If the locking lever does not move to the fully locked position, break open the action



Picture 32

Loading and Unloading Your Combination Rifle/Shotgun (cont'd)

3(cont'd) .again and check to see if the shot shell or cartridge are fully seated in the chambers. (Warning never force the barrel into the closed position). If the shell and cartridge are fully seated then reclose the action. If the shot shell and cartridge are not fully seated check the chamber for blockage and check the shell or cartridge for deformation and retry closing the action once more. (See **Picture 33**). If the shell and cartridge are the correct type and the chambers are not blocked and the shell and cartridge are not deformed and the locking lever does not move to its fully locked position unload the gun (follow Unloading Instructions) and have a competent gunsmith look at the gun or return the gun to Remington ISP for inspection. Do not force the gun closed.



Picture 33

TO UNLOAD:

1. Break open the firearm by depressing the locking lever and tipping the barrels down. (See **Picture 34**).



Picture 34

2. Remove the shell and/or cartridge by grabbing the ammunition by the rim and pulling from the chamber. (See **Picture 35**).



Picture 35

3. Visually check to make sure that the barrels are free from obstruction. (See **Picture 36**).



Picture 36

Firing Your Combination Rifle/Shotgun



WARNING: NEVER LOAD A CARTRIDGE INTO THE CHAMBER UNTIL YOU ARE READY TO FIRE YOUR COMBINATION RIFLE/- SHOTGUN.



WARNING

If a cartridge does not fire and the trigger has been pulled and the trigger block safety is disengaged... Stop! and do the following: a) Make sure the gun is pointed in a safe direction b) Engage the trigger block safety c) Wait 60 seconds d) Follow the instructions above for unloading the combination rifle/shotgun.



WARNING

If during firing the sound of any cartridge is noticeably softer or louder than the previous cartridge fired, Stop! Do not load or fire another cartridge, but do the following: a) Make sure the gun is pointed in a safe direction b) Engage the trigger block safety c) Follow the instructions above for unloading the combination rifle/shotgun and d) With the combination rifle/shotgun unloaded visually inspect the combination rifle/shotgun for barrel blockage or damage. Then inspect the receiver of the combination rifle/shotgun for damage before continuing.

READ, UNDERSTAND AND FOLLOW ALL WRNINGS AND INSTRUCTIONS IN THIS MANUAL BEFORE FIRING THE COMBINATION RIFLE/SHOTGUN.

TO FIRE THE COMBINATION RIFLE/SHOTGUN:

1. Make sure the combination rifle/shotgun is pointed in a safe direction with the trigger block safety engaged. (See **Picture 37**).
2. Make sure you are wearing eye and ear protection.
3. Keeping your fingers away from the trigger, push the trigger block safety to the "off" or "fire" position with the red ring showing. (See **Picture 38**).
4. With the butt stock held firmly against your shoulder and the barrels pointed toward your intended target, place your trigger finger on the trigger. The combination rifle/shotgun will fire the selected barrel when you pull or squeeze the trigger with the requisite force.
5. If you wish to fire a second shot from the second barrel, you have two options: Either (a) recock the gun using the cocking lever described above and then move the barrel selector to the unfired barrel (follow all procedures as stated above before firing) or (b) break open action and close action to recock the hammer and then move the barrel selector to the unfired barrel (follow all procedures as stated above before firing).



Picture 37

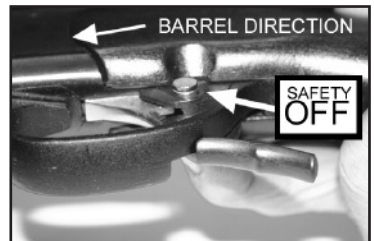

Picture 38



WARNING

Once you have stopped firing the combination rifle/shotgun, immediately push the trigger block safety to the "on" or "safe" position. Then follow the unloading instructions above while keeping the muzzle pointed in a safe direction.

Instructions For Disassembly Of The Combination Rifle/Shotgun

1. Make sure the combination rifle/shotgun is unloaded (**FOLLOW UNLOADING INSTRUCTIONS**) and pointed in a safe direction.
2. Make sure the trigger block safety is engaged in the "ON" or "SAFE" position. (See **Picture 39**).



Picture 39

3. Remove the forend from the barrel by pulling out the lever in the lower center of the forend and removing the forend in a downward outward swinging motion. Never force the forend off the barrel and receiver.
4. With the barrels and receiver supported with one hand depress the cocking lever/locking lever fully and tip the barrels down until they disengage from the receiver. Check the barrels for damage and blockage after removal.

Manufacturer's Warning

This firearm was manufactured to properly perform with the original parts as designed. It is your duty to make sure any parts you buy are correctly installed and that neither replacements nor originals are altered or changed. Your firearm has many parts that must relate correctly to other parts for safe and accurate operation. Putting a gun together wrong or with modified parts can result in a damaged gun, or personal injury or death to you or others. Always let a qualified gunsmith work on your gun or at least, check any work not performed by a gunsmith. Firearms safety is your primary concern. **THE GUN OWNER MUST ACCEPT FULL RESPONSIBILITY FOR THE CORRECT REASSEMBLY AND FUNCTIONING OF THE FIREARM AFTER ANY DISASSEMBLY OR REPLACEMENT OF PARTS.**

To Clean and Maintain Your Shotgun

- A. Follow procedures for unloading shotgun as described previously.
- B. Follow procedures for disassembly of shotgun as described previously.
- C. Materials needed to clean this shotgun are: a cleaning rod, cotton bore patches, brass bore brush, powder solvent (such as Remington BriteBore™), a small soft brush and good quality gun oil (such as Rem® Oil).

WARNING

Lead or lead compounds are known to the State of California to cause cancer, birth defects, reproductive toxicity, and other serious physical injury. Those who clean firearms should take protective measures to avoid contact or exposure to such chemicals.

- D. Using the bore brush with powder solvent, scrub the interior of the barrel and chamber to remove any powder and lead residue in the bore. Always and lastly, swab the interior of the barrel with a cotton patch with gun oil to coat and protect the bore and chambers from rust and corrosion.
- E. Any powder fouling on the firing wall, barrel, etc. can be easily cleaned with a brush and powder solvent.
- F. All external surfaces should be wiped down with a light coat of rust preventative. Avoid using too much oil as powder, dust or other foreign material may get trapped in the oil. This could lead to congealed deposits which may interfere with the safe and reliable operation of this shotgun.
- G. **USE CAUTION** while using solvents in gun bore cleaning. Prolonged or excess contact with solvents can damage the gun's bluing and finish. Be sure to wipe away all excess solvent and then lubricate with oil.
- H. A gun should be cleaned after firing. In addition, external parts should be wiped with an oiled cloth after handling. A light oil is ordinarily all that is necessary in cleaning if the gun has not been fired or fired very little. If a gun is used frequently, it must be cleaned after each firing and regularly serviced by a professional gunsmith. If the gun has been stored, remove all excess oil and/or grease before firing. Always check to be sure that no cleaning patch or other obstruction remains in the bore or chambers before firing.

DANGER – Ammunition Warning

Firearms may be damaged and serious personal injury or death to the shooter or bystanders may result from any condition which contributes to the generation of excessive pressure or uncontrolled release of gas within the firearm. Such adverse conditions can be caused by bore or chamber obstructions, propellant powder overloads or by defective, incorrect or improperly loaded and assembled cartridge components. Even the strongest firearm can be blown up as a result of excessive pressure. It is extremely dangerous to use a cartridge whose pressure is greater than that developed by cartridges loaded to industry standards.

Ammunition (Cartridges) Notice

We specifically disclaim responsibility for any damage, injury or death occurring in connection with or as the result of the use of the combination rifle/shotgun with faulty, non-standard, remanufactured, hand loaded or reloaded ammunition or with cartridges other than factory cartridges for which the shotgun was originally chambered.

Lubrication Warning

Firing a shotgun with oil, grease or any other material even partially obstructing the bore may result in damage to the shotgun and personal injury to the shooter and those nearby. Do not spray or apply lubricants directly on ammunition. If the powder charge of a cartridge is affected by the lubricant, they may not fully ignite yet the energy from the primer and/or powder may still be sufficient to push the projectile or wad into the bore where it may become lodged. Firing a subsequent cartridge into the obstructed bore will damage the shotgun and may cause personal injury to the shooter and those nearby. Use lubricants properly. You are responsible for the proper care and maintenance of your firearm and ammunition.

PARTS AND SERVICE

To Order Parts

ALL PARTS ARE SUBJECT TO A \$10.00 CHARGE FOR SHIPPING AND HANDLING. Some parts are restricted and may only be installed by returning the shotgun to us. When ordering parts, please state the Model, Gauge, Serial Number, and Finish Color. For parts information, call (321) 639-1432.

Service

To obtain information about returning your shotgun for service or repairs, call (321) 639-1432.

One Year Limited Warranty

This shotgun is warranted to the original retail customer for one year from the date of retail purchase against defects in material and workmanship. All parts and labor or replacement **at our option** are covered. The wood stock is not covered by the one year warranty. The warranty on the wood stock is 60 days and is limited to the original retail customer and extends 60 days from the date of retail purchase and covers only manufactured and material defects.

PARTS AND SERVICE (cont'd)

One Year Limited Warranty

Transportation to and from our repair facilities, government fees, damage caused by failure to perform normal maintenance, sales outside the United States, damage caused by use of high velocity, high pressure, reloaded or other nonstandard ammunition, or by any unauthorized repair, modification, misuse, abuse or alteration of the shotgun is not covered by this Limited Warranty.

Implied Warranty

ANY IMPLIED WARRANTIES, INCLUDING THE IMPLIED WARRANTIES OF MERCHANT ABILITY AND FITNESS FOR A PARTICULAR PURPOSE, ARE LIMITED IN DURATION TO ONE YEAR FROM THE DATE OF ORIGINAL RETAIL PURCHASE. SOME STATES DO NOT ALLOW LIMITATIONS ON HOW LONG AN IMPLIED WARRANTY LASTS, SO THE ABOVE LIMITATION MAY NOT APPLY TO YOU.

To the extent any provision of this warranty is prohibited by federal, state, or municipal law, which cannot be pre-empted, it shall not be applicable. This warranty gives you specific legal rights, and you may also have other rights which may vary from state to state.

To obtain warranty service, send your shotgun with proof of retail purchase, freight prepaid to:

REMINGTON I.S.P.
c/o USSG
402 Richard Road
Rockledge, FL 32955

NOTICE: It is illegal to ship a firearm with ammunition in the firearm or in the same packaging. Firearms and ammunition must be shipped separately. For information about shipping ammunition, call (321) 639-1432.

Your Owner's Manual

Always keep this manual with your combination rifle/shotgun. Make sure you understand all the warnings, operation instructions and safety procedures. When you lend, give or sell the firearm, be sure this manual goes with it. You can get a copy of this manual from Remington upon request.

Optional Shotgun Barrel Choke Tubes

WARNING

Never install or remove choke tubes while the firearm is loaded. Only install or remove choke tubes with the firearm unloaded, the action open and the trigger block safely engaged.

Screw in Chokes Symbols/Markings

The end of the choke tubes are marked with slashes to identify the choke construction:

- / - Full
- // - Improved Modified
- /// - Modified
- //// - Improved Cylinder
- CI - Cylinder

WARNING

MAKE SURE YOU FULLY TIGHTEN THE CHOKE TUBE.

Shooting with a loose choke tube can cause damage to your shotgun.

Additional Information On Screw Choke Tubes:

- A. Only tighten or loosen choke tubes with flat key wrench supplied with shotgun. Note: wrench (and extra choke tube or tubes if supplied) are under the cardboard in front of the combination rifle/shotgun receiver in the box.
- B. Never shoot the combination rifle/shotgun with a partially installed choke tube.
- C. Model SPR 94 combination rifle/shotguns are available with fixed choke or screw choke shotgun barrels. There are two types of screw chokes available: lead shot choke tubes and steel shot choke tubes. When installed, steel shot choke tubes protrude approximately $\frac{3}{4}$ " from the muzzle end of the barrel and the mating lip will be flush with the end of the barrel. When installed, lead shot choke tubes fit flush with or slightly below the muzzle end of the barrel. If you have lead shot choke tubes and intend to shoot steel shot cartridges or slugs, then you must use only the IC or Cylinder tubes. DO NOT fire steel shot or slugs in Modified, Improved Modified or Full lead shot choke tubes. If you have steel shot choke tubes, you may fire steel shot cartridges through any of those choke tubes. DO NOT fire slugs in Modified, Improved Modified or Full lead shot choke tubes or steel shot choke tubes.

Chart of Model SPR 94 Rifling Dimensions

Caliber of IZH94	Rifling Rate of Twist		Rifling Groove		Rifling Land	
	millimeter	inches	millimeter	inches	millimeter	inches
22LR	410	16.14	5.6	0.220	5.45	0.215
22WMR	406	15.98	5.69	0.224	5.56	0.219
17HMR	229	9.02	4.37	0.172	4.27	0.168

PARTS LIST

Exploded View SPR 94 .410 Ga. Combination Rifle/Shotgun

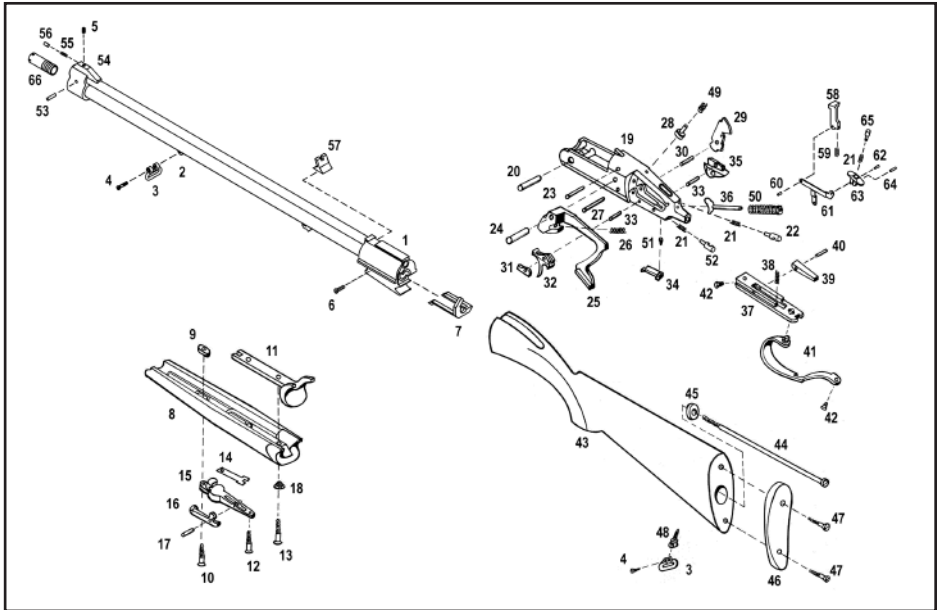

List of SPR 94 Combination Rifle/Shotgun Components

- | | | |
|------------------------------|------------------------------------|-----------------------------|
| 1. barrel assembly | 29. cam pin | 55. safety |
| 2. extractor spring | 30. sear pin | 56. sear lifter lever |
| 3. plunger | 31. left sear | 57. sear lifter |
| 4. right extractor | 32. left hammer assembly | 58. sear lifter spring |
| 5. left extractor | 33. plug | 59. sear lifter level pin |
| 6. screw | 34. plug screw | 60. pin |
| 7. pin | 35. follower | 61. screw |
| 8. sling swivel ring | 36. left rod assembly | 62. trigger plate |
| 9. screw | 37. right rod assembly | 63. screw |
| 10. barrel sling swivel base | 38. cocking lever | 64. trigger guard |
| 11. front sight | 39. cocking lever pin | 65. trigger guard screw |
| 12. forend | 40. screw | 66. right trigger |
| 13. washer | 41. locking lever | 67. trigger spring |
| 14. spring | 42. right hammer assembly | 68. left trigger |
| 15. latch body | 43. hammer pin | 69. pin |
| 16. forend latch | 44. right sear | 70. stock |
| 17. pin | 45. pin for safety and thumb piece | 71. screw |
| 18. screw | 46. thumb piece | 72. washer |
| 19. screw | 47. locking bolt | 73. butt plate |
| 20. screw | 48. connecting rod | 74. woodscrew |
| 21. lever pin | 49. locking bolt spring | 75. woodscrew |
| 22. left lever | 50. cam stop | 76. stock sling swivel base |
| 23. right lever | 51. threaded connecting piece | 77. sear spring |
| 24. hinge | 52. locking bolt lever | 78. wright |
| 25. lever spring | 53. ball | 79. pin |
| 26. screw | 54. sear lifter lever spring | 80. safety spring |
| 27. receiver | | 81. bushing |



WARNING

Children are attracted to and can operate firearms that can cause severe injuries or death. Prevent child access by always keeping guns locked away and unloaded when not in use. If you keep a loaded firearm where a child obtains and improperly uses it, you may be fined or sent to prison.



ADVERTENCIA

A los niños les atraen las armas de fuego y los pueden hacer funcionar. Ellos pueden causarse lesiones graves y la muerte. Evite que los niños tengan acceso a las armas de fuego guardándolas siempre con llave y descargadas cuando no las esté utilizando. Si usted tiene un arma de fuego cargada en un lugar en que un niño tiene acceso a ella y la usa indebidamente. Le pueden dar una multa o enviarlo a la cárcel.

REMINGTON I.S.P.
c/o USSG
402 Richard Road
Rockledge, FL 32955

Manufacturer:

Izhevsky Mekhanichesky Zavod
8, Promyshlennaya str.,
426063 Izhevsk, Russia

Remington®

Remington is a trademark registered in the United States Patent and Trademark Office by Remington Arms Company, Inc.