

BRINKMANN®

Qbeam®

**MAX
MILLION™**

RECHARGEABLE

1,000,000 CANDLEPOWER

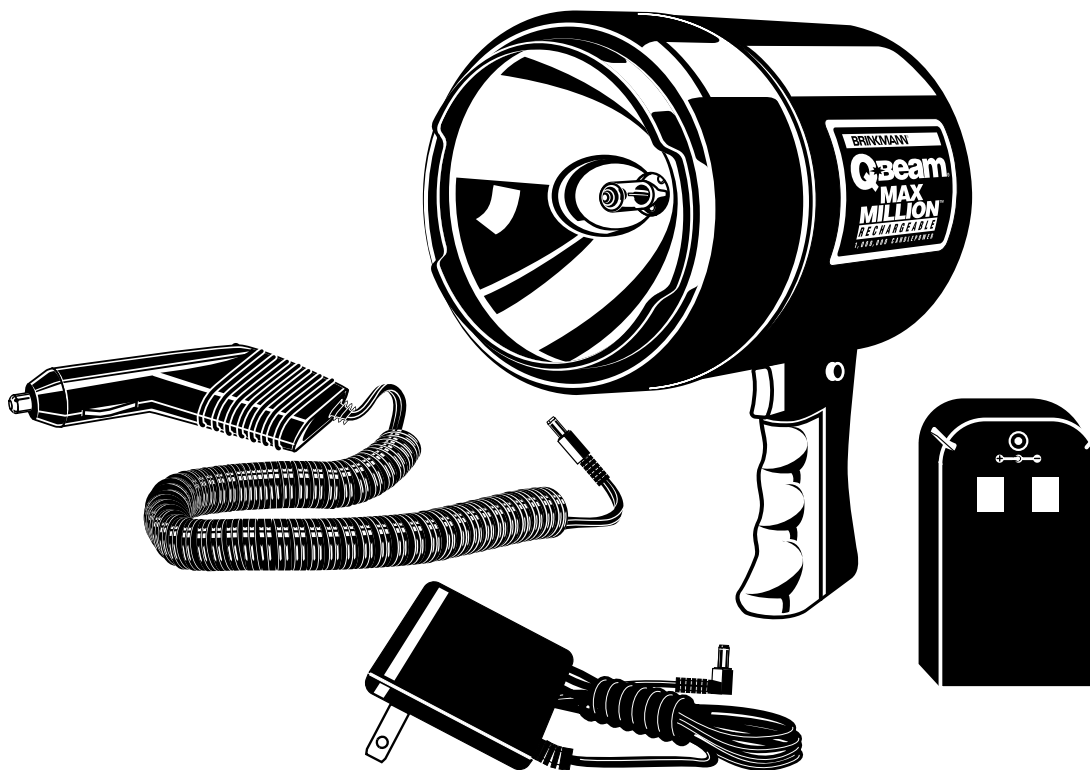

OWNER'S MANUAL
OPERATING INSTRUCTIONS

IMPORTANT SAFETY WARNINGS



READ AND FOLLOW ALL SAFETY WARNINGS AND INSTRUCTIONS IN THE OWNER'S MANUAL BEFORE OPERATING SPOTLIGHT.

WARNING

- Never place spotlight face down when light is on. Doing so could burn/ignite surfaces such as seats, carpeting, etc. and cause serious property damage. Always turn spotlight off when not in use.
- To prevent serious damage to eyesight, never look into spotlight when light is on. Do not shine light into the face of someone else.
- Do not touch lens of spotlight when light is on or if it was recently on. The lens will be hot and could cause serious burns.
- Do not place spotlight in water. Keep all components dry and out of water at all times.
- Do not allow children to handle or operate this spotlight.
- Do not use this product for other than its intended use.
- Do not charge or operate in close proximity of combustible or flammable materials.
- Do not charge battery in gas tight enclosures.
- Do not attempt to charge or operate this spotlight if cord, plug, battery, bulb or any part of the spotlight is damaged or corroded.
- Do not allow metal parts to touch metal contacts on battery as this can cause a short circuit and result in a fire.
- Do not use an outdoor AC outlet to recharge battery.
- Only use charging devices that are provided with the Q-Beam Max Million Rechargeable Spotlight or its replacements.
- Do not disassemble or tamper with the battery.
- Do not dispose of battery in fire as this may result in explosion.
- When disposing of battery, place electrical tape over metal contacts on battery to prevent short circuit which could cause a fire.
- The sealed battery contains lead and must be recycled or disposed of properly. Contact your local county solid waste authority for proper recycling or disposal information.

USE CAUTION AND COMMON SENSE WHEN OPERATING YOUR RECHARGEABLE LIGHT.

**FAILURE TO ADHERE TO THE SAFETY WARNINGS AND GUIDELINES IN THIS MANUAL
COULD RESULT IN BODILY INJURY OR PROPERTY DAMAGE.**

SAVE THIS MANUAL FOR FUTURE REFERENCE.

OPERATING INSTRUCTIONS

⚠ READ AND FOLLOW ALL SAFETY WARNINGS AND INSTRUCTIONS IN THE OWNER'S MANUAL BEFORE OPERATING SPOTLIGHT.

Inspect contents of the box to ensure all parts are included and undamaged.

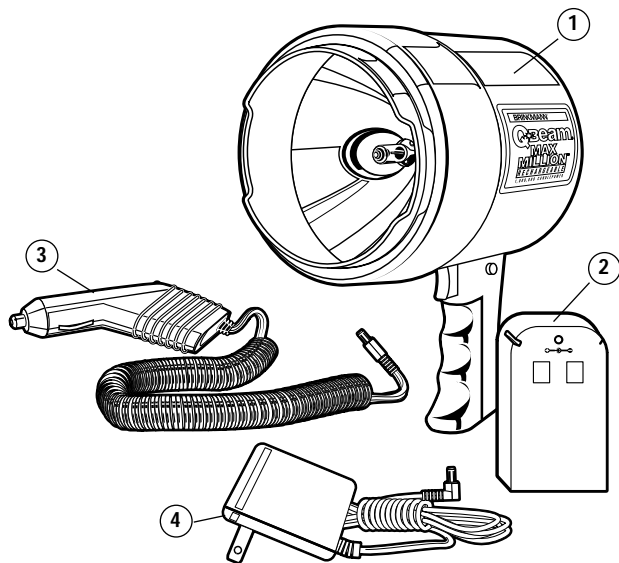

Part List:

- ① O-Beam Max Million Rechargeable Spotlight
 - ② Rechargeable Battery
 - ③ 12-volt DC Charger
 - ④ 110-volt AC Charger
- Owner's Manual

- Step 1:** Follow charging instructions on page 3 of this manual and allow battery to fully charge.
- Step 2:** Depress trigger switch in handle to turn spotlight ON. Release trigger switch to turn spotlight OFF.
- Step 3:** To lock trigger switch to ON, depress trigger switch and push in lock button on side of handle. To unlock and turn spotlight OFF, depress trigger switch and release.

⚠ WARNING: Never place spotlight face down when light is on. Doing so could burn/ignite surfaces such as seats, carpeting, etc. and cause serious property damage. Always turn spotlight off when not in use.

- The life expectancy of the battery is approximately 500 cycles, at which time a replacement battery is recommended. A replacement battery may be purchased from The Brinkmann Corporation Customer Service Department by calling 1-800-468-5252.
- A fully charged battery will provide approximately 20 minutes of continuous light.
- Do not allow battery to completely discharge. A dim light indicates a low battery. Recharge battery as soon as possible after each use.

To Operate

IMPORTANT: Unlock and turn spotlight OFF before charging from AC or DC outlet. The battery cannot charge if the spotlight is ON. Leaving spotlight ON during charging may cause damage to battery and chargers.

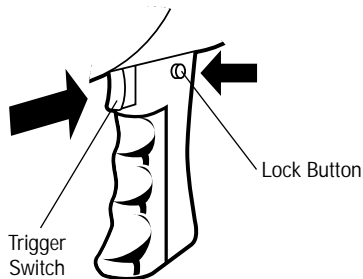

To Charge

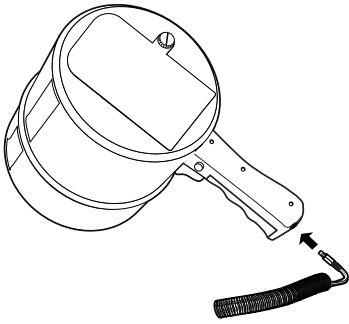

IMPORTANT: If battery is not used for more than 90 days, remove battery from the spotlight. Charge battery every 2 months for 12 hours to ensure battery does not completely lose charge. A completely discharged battery may not recharge properly.

THE BATTERY CAN BE CHARGED INSIDE OR OUTSIDE OF SPOTLIGHT.

To Charge Battery Inside of Spotlight:

- Step 1:** Make sure the trigger switch is not locked ON.
- Step 2:** Plug the AC or DC charger into bottom of spotlight handle.
- Step 3:** **For DC Charger** - Allow battery to fully charge using the DC charger for at least 36 hours. Do not charge for more than 48 hours.
For AC Charger - Allow battery to fully charge using the AC charger for at least 18 hours. Do not charge for more than 24 hours.
See chart for recommended charge times.

Charge Times

Charge times are dependent on usage of the product. See chart below for recommended charge times.

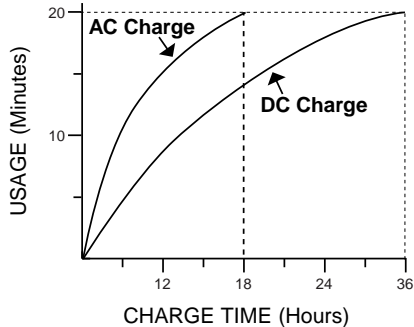

- ⚠ WARNING:** A damaged battery can leak acid. Avoid contact with eyes and skin. If contact occurs, flush immediately with large amounts of water. Do not ingest. If contact with eyes or ingestion occurs, consult physician immediately.

To Charge Battery Outside of Spotlight:

- Step 1:** Remove battery from back of spotlight by turning door knob counter-clockwise and lifting off door.

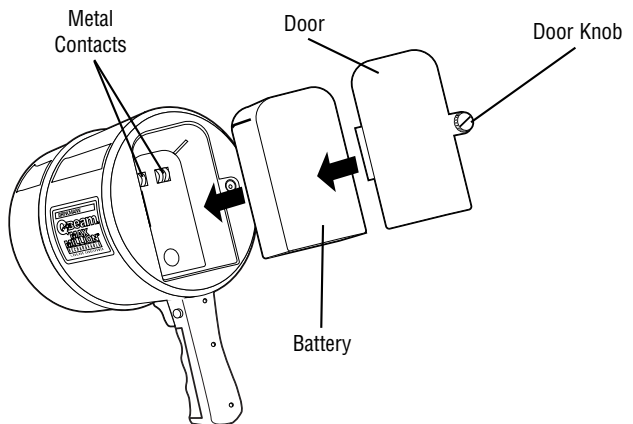

- Step 2:** Plug the AC or DC charger into battery as illustrated.
- Step 3:** **For DC Charger** - Allow battery to fully charge using the DC charger for at least 36 hours. Do not charge for more than 48 hours. **For AC Charger** - Allow battery to fully charge using the AC charger for at least 18 hours. Do not charge for more than 24 hours. See chart for recommended charge times.

IMPORTANT: If battery is not used for more than 90 days, remove battery from the spotlight. Charge battery every 2 months for 12 hours to ensure battery does not completely lose charge. A completely discharged battery may not recharge properly.

⚠ WARNING: A damaged battery can leak acid. Avoid contact with eyes and skin. If contact occurs, flush immediately with large amounts of water. Do not ingest. If contact with eyes or ingestion occurs, consult physician immediately.

- Step 4:** Place charged battery inside light so that metal contacts on battery and light are making contact.

For extended lighting requirements, we recommend purchasing an additional battery as a back-up. Additional/replacement batteries may be purchased from The Brinkmann Corporation Customer Service Department by calling 1-800-468-5252.

Only use Brinkmann's 6V55W halogen bulb that is designed for the Q-Beam Max Million Rechargeable spotlight as a replacement. Use of any other bulb may result in poor performance and may damage your spotlight.

IMPORTANT: Do not touch the glass part of bulb with fingers as natural oils affect the life and performance of bulb. Handle bulb by metal end only.

- Step 1:** Disconnect spotlight from power source.
- Step 2:** Remove battery from spotlight.
- Step 3:** Remove the two screws from top and bottom of front housing.
- Step 4:** Lay the spotlight face (lens) down on a flat surface.

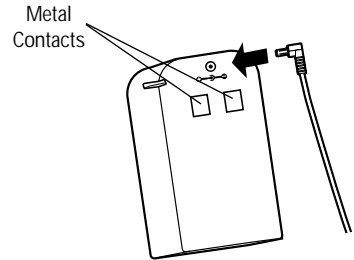

To Replace Bulb

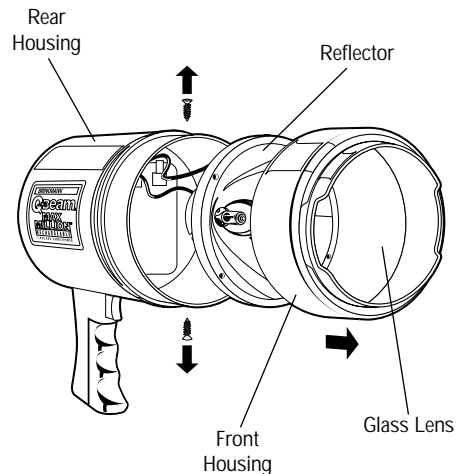

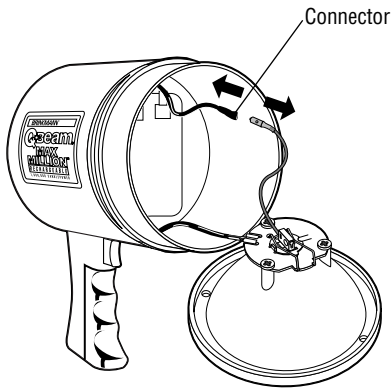

Step 5: Holding the front housing secure, slowly lift the rear housing off being careful not to pull wire connections inside. Do not touch the inside of reflector.

NOTE: The glass lens is not attached to front housing. Use care when disassembling to avoid breaking lens.

Step 6: Spread the wire retainer apart and lift up as illustrated.

Step 7: Pull bulb straight out from the reflector mounting plate.

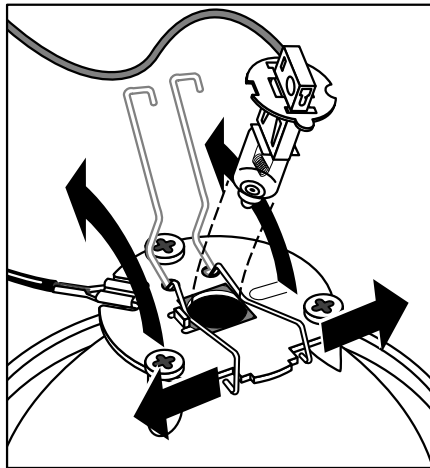

Step 8: Disconnect bulb wire from connector by holding the connector firmly with fingers then pulling bulb wire straight out.

Step 9: To install new bulb, grasp the bulb from the metal end (DO NOT TOUCH THE GLASS PART) and insert into the reflector mounting plate. Align the slots in the bulb base with those in the reflector mounting plate.

Step 10: Replace wire retainer by spreading ends apart while pressing down. Push ends together so they catch on the reflector mounting plate.

Step 11: Reconnect the bulb wire to the connector as illustrated.

Step 12: To reassemble, place the front housing face (lens) down on a flat surface. Set the reflector into the front housing. Insert the rear housing into the front housing of the spotlight.

Step 13: Replace the two screws that were removed in Step 3. Do not over tighten screws.

Replacement bulbs may be purchased from The Brinkmann Corporation Customer Service Department by calling 1-800-468-5252.

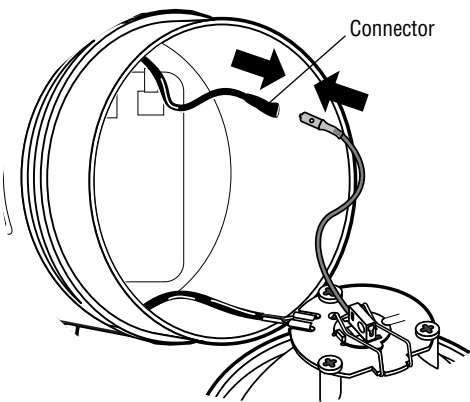

To Prevent Damage to Spotlight and Battery:

- Do not attempt to use spotlight while charging directly from AC or DC outlet. Doing so may cause damage to the chargers.
- Only use charging devices that are provided with the Q-Beam Max Million Rechargeable Spotlight or its replacements.
- **For DC Charger** - Allow battery to fully charge using the DC charger for at least 36 hours. Do not charge for more than 48 hours.
For AC Charger - Allow battery to fully charge using the AC charger for at least 18 hours. Do not charge for more than 24 hours.
See chart for recommended charge times.
- Do not allow battery to completely discharge. A dim light indicates a low battery. Recharge battery as soon as possible after each use.
- Always keep the battery fully charged when not in use.

Charging Tips

Charge Times

Charge times are dependent on usage of the product. See chart below for recommended charge times.

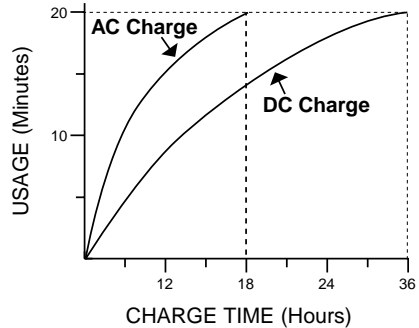

ACCESSORIES

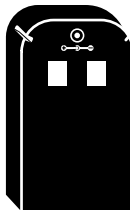
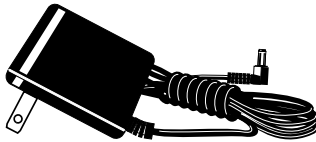
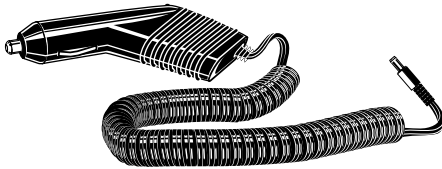

12-Volt DC Charger

Model 802-0013-0

12-volt DC charger for use with Max Million Rechargeable Spotlight.

110-Volt AC Charger

Model 802-0012-0

110-volt AC charger for use with Max Million Rechargeable Spotlight.

6-Volt Rechargeable Battery

Model 802-2605-0

Replacement lead acid, 6-volt, 4.5 A.H. rechargeable battery for use with Q-Beam Max Million Rechargeable Spotlight.

Replacement Bulb for Max Million Rechargeable

Model 802-1741-0

6-volt, halogen 55-watt bulb is an original replacement for Q-Beam Max Million Rechargeable Spotlight.

1-YEAR LIMITED WARRANTY

For 1-year from date of purchase, The Brinkmann Corporation warrants the Max Million Rechargeable Light against defects due to workmanship or materials to the original purchaser. The Brinkmann Corporation's obligations under this warranty are limited to the following guidelines:

- This warranty does not extend to the bulb or battery.
- This warranty does not cover rechargeable lights that have been altered or damaged due to: normal wear, abuse, improper maintenance, improper use, disassembly of parts and/or attempted repair by anyone other than an authorized employee of The Brinkmann Corporation.
- This warranty does not cover surface scratches or weathering as this is considered normal wear.
- Warranty service is limited to repair or replacement of rechargeable lights which prove defective under normal use and which upon examination shall indicate to Brinkmann's satisfaction, they are defective. If Brinkmann confirms the defect and approves the claim, Brinkmann will elect to repair or replace the rechargeable light as covered by the terms of this warranty.
- This warranty extends to the original purchaser only and is not transferable or assignable to subsequent purchasers.

The Brinkmann Corporation requires reasonable proof of purchase. Therefore, we strongly recommend that you retain your sales receipt or invoice. To obtain repair or replacement of your Max Million Rechargeable Light under the terms of this warranty, please call Customer Service Department at 1-800-527-0717 for a Return Authorization Number and further instructions. A receipt will be required. Rechargeable lights returned to Brinkmann must include your name, address and telephone number. Please make sure the light is properly packed, postage prepaid, and insured. A Return Authorization Number must be clearly marked on the outside of the box. Brinkmann cannot be responsible for any rechargeable lights forwarded to us without a Return Authorization Number.

EXCEPT AS ABOVE STATED, THE BRINKMANN CORPORATION MAKES NO OTHER EXPRESS WARRANTY.

THE IMPLIED WARRANTIES OF MERCHANTABILITY AND FITNESS FOR A PARTICULAR PURPOSE ARE LIMITED IN DURATION TO 1-YEAR FROM THE DATE OF PURCHASE. SOME STATES DO NOT ALLOW LIMITATIONS ON HOW LONG AN IMPLIED WARRANTY LASTS, SO THE ABOVE LIMITATION MAY NOT APPLY TO YOU.

ANY LIABILITY FOR INDIRECT, INCIDENTAL OR CONSEQUENTIAL DAMAGES ARISING FROM THE FAILURE OF THE MAX MILLION RECHARGEABLE LIGHT TO COMPLY WITH THIS WARRANTY OR ANY IMPLIED WARRANTY IS EXCLUDED. CUSTOMER ACKNOWLEDGES THAT THE PURCHASE PRICE CHARGED IS BASED UPON THE LIMITATIONS CONTAINED IN THE WARRANTY SET OUT ABOVE. SOME STATES DO NOT ALLOW THE EXCLUSION OR LIMITATION OF INCIDENTAL OR CONSEQUENTIAL DAMAGES, SO THE ABOVE LIMITATION OR EXCLUSION MAY NOT APPLY TO YOU. THIS WARRANTY GIVES YOU SPECIFIC LEGAL RIGHTS, AND YOU MAY ALSO HAVE OTHER RIGHTS WHICH VARY FROM STATE TO STATE.