

BRINKMANN®

Q-beam®

MAX MILLION™ Spotlight &
Magnum Max® 850,000 CP Spotlight

⚠ WARNING

READ AND FOLLOW ALL WARNINGS
AND INSTRUCTIONS IN THIS
MANUAL TO AVOID PERSONAL
INJURY OR PROPERTY DAMAGE.



OWNER'S MANUAL &
OPERATING INSTRUCTIONS

IMPORTANT SAFETY WARNINGS

 **READ AND FOLLOW ALL SAFETY WARNINGS AND INSTRUCTIONS IN THE OWNER'S MANUAL BEFORE OPERATING SPOTLIGHT.**

WARNING

- Never place spotlight lens (face) down when light is on or is still hot from recent use. Doing so could burn/ignite surfaces such as seats, carpeting, etc. and cause major property damage. Always turn spotlight off and unplug from power source when not in use.
- To prevent serious damage to eyesight, never look into spotlight when light is on. Do not shine light into the face of someone else.
- Do not touch lens of spotlight when light is on or if it was recently on. The lens will be hot and could cause serious burns.
- Keep battery clips or cigarette lighter plug dry and out of water at all times.
- Do not place spotlight in water.
- Do not allow children to handle or operate this spotlight.
- Do not use this product for other than its intended use.
- Do not operate in close proximity of combustible or flammable materials.
- Do not attempt to operate spotlight if cord, plug, bulb or any part of the spotlight is damaged or corroded.

USE CAUTION AND COMMON SENSE WHEN OPERATING YOUR SPOTLIGHT.

**FAILURE TO ADHERE TO THE SAFETY WARNINGS AND GUIDELINES IN THIS MANUAL
COULD RESULT IN BODILY INJURY OR PROPERTY DAMAGE.**

SAVE THIS MANUAL FOR FUTURE REFERENCE.

Tips to Avoid Damage to Your Q-Beam Spotlight

- Never attempt to wipe or clean the inner reflective surface of the reflector. Touching or wiping the surface will damage it permanently.
- The lens is made of optical-quality, tempered glass. As with all glass, avoid dropping or sharp impact on spotlight.
- Do not allow the hot lens to come in contact with water or materials subject to heat damage.
- This spotlight is weather resistant. It is not waterproof. Do not use the spotlight under water or store outdoors.
- Only use a Brinkmann 12-volt, halogen bulb that is designed for your Q-Beam spotlight. Use of any other bulb may result in poor performance and may damage your spotlight.
- After months of use, cigarette lighters can build up corrosion that may prevent your Q-Beam spotlight from making good contact. It may be necessary to clean the inside of your cigarette lighter receptacle with a fine emery cloth. Before cleaning receptacle, remove the fuse to prevent it from shorting out.

OPERATING INSTRUCTIONS

⚠ READ AND FOLLOW ALL SAFETY WARNINGS AND INSTRUCTIONS IN THE OWNER'S MANUAL BEFORE OPERATING SPOTLIGHT.

Step 1: To activate spotlight, plug the cigarette lighter adapter into a cigarette lighter receptacle. Move switch to ON.

⚠ WARNING: Never place spotlight lens face down when light is on or is still hot from recent use. Doing so could burn/ignite surfaces such as seats, carpeting, etc. and cause major property damage. Always turn spotlight off and unplug from power source when not in use.

Step 2: To deactivate, move switch to OFF and unplug from power source.



Only use a Brinkmann halogen bulb that is designed for the Q-Beam Max Million or Magnum Max 850,000 CP spotlight as a replacement. Use of any other bulb may result in poor performance and may damage your spotlight.

IMPORTANT: Do not touch the glass part of bulb with fingers as natural oils affect the life and performance of bulb. Handle bulb by metal end only.

Step 1: Disconnect spotlight from power source.

Step 2: Remove the two screws from top and bottom of front housing (see Figure 1).

Step 3: Lay the spotlight face (lens) down on a flat surface.

Step 4: Holding the front housing secure, slowly lift the rear housing off being careful not to pull wire connections inside. Make sure the reflector is inside the front housing as shown in Figure 2. Do not touch the inside of reflector.

NOTE: The glass lens is not attached to front housing. Use care when disassembling to avoid breaking lens.

To Replace Bulb

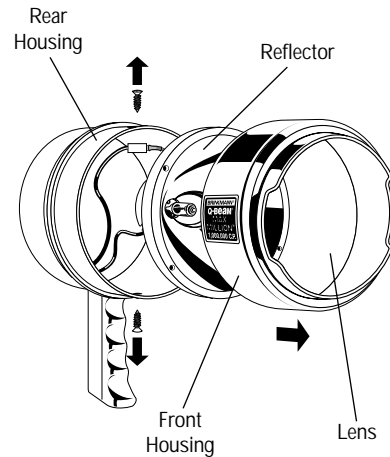

FIGURE 1

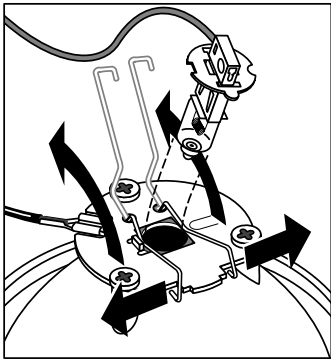

FIGURE 3

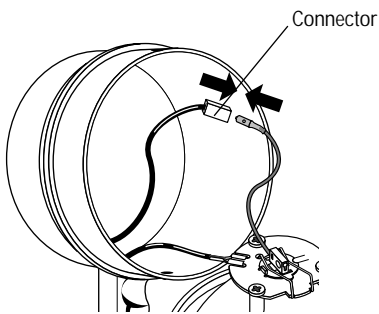

FIGURE 4

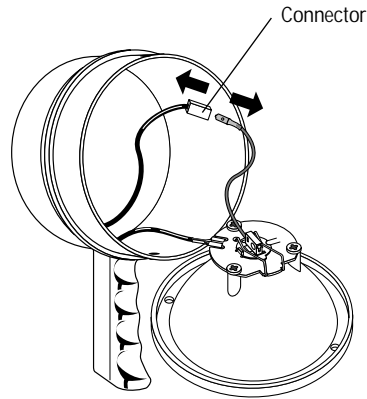

FIGURE 2

- Step 5:** Disconnect bulb wire from connector by holding the connector firmly with fingers then pulling bulb wire straight out as shown in Figure 2.
- Step 6:** Spread the wire retainer apart and lift up as illustrated in Figure 3.
- Step 7:** Pull bulb straight out from the reflector mounting plate.
- Step 8:** To install new bulb, grasp the bulb from the metal end (DO NOT TOUCH THE GLASS PART) and insert into the reflector mounting plate. Align the slots in the bulb base with those in the reflector mounting plate.
- Step 9:** Replace wire retainer by spreading ends apart while pressing down. Push ends together so they catch on the reflector mounting plate.
- Step 10:** Reconnect the bulb wire to the connector as illustrated in Figure 4.
- Step 11:** To reassemble spotlight, leave the front housing face (lens) down on a flat surface with the reflector in the front housing. Insert the rear housing into the front housing of the spotlight.
- Step 12:** Replace the two screws that were removed in Step 2. Do not over tighten screws.

Replacement bulbs and accessories may be purchased from The Brinkmann Corporation Consumer Sales Department by calling 1-800-468-5252.

Q-BEAM ACCESSORIES

Rechargeable Battery Pack With Carrying Case

12-volt rechargeable battery pack adds total mobility to your Q-Beam. Includes cigarette lighter receptacle, 120-volt charging transformer and a heavy-duty, woven nylon carrying case with shoulder strap.

Model 802-1724-1 Black

Model 802-1725-1 Green Camo

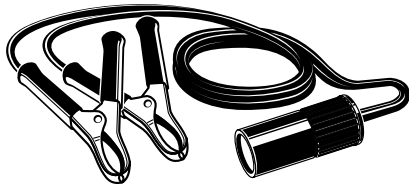

Pigtails Adapters

Pigtails adapter with battery terminal clips allow Q-Beam spotlights with cigarette lighter plug to operate directly from a 12-volt battery.

Model 802-1704-0 (2-Ft. Cord)

Model 802-1705-0 (10-Ft. Cord)

Lighter Plug Extension Cord

Features a 15-ft. cord with a cigarette lighter plug and receptacle.

Model 802-1706-0



**LOOK FOR THESE ACCESSORIES AT YOUR LOCAL RETAILER
WHERE Q-BEAMS ARE SOLD, OR ORDER DIRECT
BY CALLING 1-800-468-5252.**

Q-BEAM ACCESSORIES



Wall Mount Bracket

Mounts to any flat surface for storage of Q-Beam spotlights. Screws included.

Model 802-1708-0

Carrying Case

Black, vinyl carrying case is ideal for storage and transport of your Q-Beam hand-held spotlight.

Model 802-1702-0

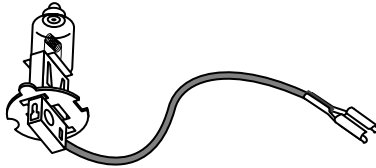

Replacement Bulb

12-volt, halogen bulb is an original replacement for Q-Beam Max Million or Magnum Max 850,000 CP spotlights.

Model 802-1740-0 Max Million Spotlight

Model 802-1742-0 Magnum Max Spotlight

Snap-On Lens Filter

Filter lens snap-on easily to Q-Beam spotlight for color and visual effect.

Model 802-1703-1 Amber

Model 802-1703-2 Red

Model 802-1703-3 Blue

Model 802-1703-4 Assortment Pack

(1 Amber, 1 Red, 1 Blue)

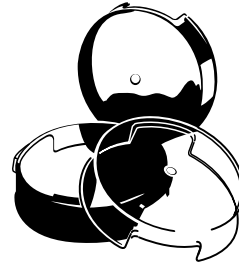

**LOOK FOR THESE ACCESSORIES AT YOUR LOCAL RETAILER
WHERE Q-BEAMS ARE SOLD, OR ORDER DIRECT
BY CALLING 1-800-468-5252.**

1-YEAR LIMITED WARRANTY

For 1-year from date of purchase, The Brinkmann Corporation warrants the Q-Beam Max Million/Magnum Max Spotlight against defects due to workmanship or materials to the original purchaser. The Brinkmann Corporation's obligations under this warranty are limited to the following guidelines:

- This warranty does not extend to the bulb.
- This warranty does not cover spot lights that have been altered or damaged due to: normal wear, abuse, improper maintenance, improper use, disassembly of parts and/or attempted repair by anyone other than an authorized employee of The Brinkmann Corporation.
- This warranty does not cover surface scratches or weathering as this is considered normal wear.
- Warranty service is limited to repair or replacement of spotlights which prove defective under normal use and which upon examination shall indicate to Brinkmann's satisfaction, they are defective. If Brinkmann confirms the defect and approves the claim, Brinkmann will elect to repair or replace the spotlight as covered by the terms of this warranty.
- This warranty extends to the original purchaser only and is not transferable or assignable to subsequent purchasers.

The Brinkmann Corporation requires reasonable proof of purchase. Therefore, we strongly recommend that you retain your sales receipt or invoice. To obtain repair or replacement of your Q-Beam Max Million/Magnum Max Spotlight under the terms of this warranty, please call Customer Service Department at 1-800-527-0717 for a Return Authorization Number and further instructions. **A receipt will be required. A Return Authorization Number must be clearly marked on the outside of the box.** Spotlights returned to Brinkmann must include your name, address and telephone number. Please make sure the light is properly packed, postage prepaid, and insured. Brinkmann cannot be responsible for any spotlights forwarded to us without a Return Authorization Number.

EXCEPT AS ABOVE STATED, THE BRINKMANN CORPORATION MAKES NO OTHER EXPRESS WARRANTY.

THE IMPLIED WARRANTIES OF MERCHANTABILITY AND FITNESS FOR A PARTICULAR PURPOSE ARE LIMITED IN DURATION TO 1-YEAR FROM THE DATE OF PURCHASE. SOME STATES DO NOT ALLOW LIMITATIONS ON HOW LONG AN IMPLIED WARRANTY LASTS, SO THE ABOVE LIMITATION MAY NOT APPLY TO YOU.

ANY LIABILITY FOR INDIRECT, INCIDENTAL OR CONSEQUENTIAL DAMAGES ARISING FROM THE FAILURE OF THE Q-BEAM MAX MILLION/MAGNUM MAX SPOTLIGHT TO COMPLY WITH THIS WARRANTY OR ANY IMPLIED WARRANTY IS EXCLUDED. CUSTOMER ACKNOWLEDGES THAT THE PURCHASE PRICE CHARGED IS BASED UPON THE LIMITATIONS CONTAINED IN THE WARRANTY SET OUT ABOVE. SOME STATES DO NOT ALLOW THE EXCLUSION OR LIMITATION OF INCIDENTAL OR CONSEQUENTIAL DAMAGES, SO THE ABOVE LIMITATION OR EXCLUSION MAY NOT APPLY TO YOU. THIS WARRANTY GIVES YOU SPECIFIC LEGAL RIGHTS, AND YOU MAY ALSO HAVE OTHER RIGHTS WHICH VARY FROM STATE TO STATE.