



BIRCH HOUSE LANE,
COTES, SWYNNERTON,
STAFFORDSHIRE. ST15 0QQ.
ENGLAND

TEL: +44 (0)1782 791755 FAX: +44 (0)1782 791617



DAYSTATE LTD.

Small Arms Manufacturers

Birch House Lane, Cotes, Staffs. ST15 0QQ. Tel: 01782 791755 Fax: 01782 791617

Email: daystate.ltd@virgin.net

Web: <http://www.daystate.co.uk>

PLEASE READ ALL INSTRUCTIONS BEFORE USING YOUR RIFLE
IT CONTAINS IMPORTANT SAFETY & MAINTENANCE INFORMATION
FOR THE HARRIER MODEL

LOADING AND COCKING

Operate safety catch (C) ;safe when "S" mark is depressed.

Turn the breech bolt (A) anti clockwise approx 45 degrees and pull back until it clicks. The bolt slides easily when the rifle is cocked. Insert pellet into the breech (B) making sure barrel is pointing down.

Push bolt home and twist clockwise 45 degrees to lock the breech bolt. Depress safety tab on left hand side, the gun is ready to fire.

CHARGING HARRIER MODEL

Remove dust cap from front of reservoir.

Connect female Snap-On connector onto male, making sure the sleeve is fully forward and connection is secure. **If not secure the connector will disengage from the gun under pressure which could result in personal injury.**

WARNING: DO NOT PRESSURISE FEMALE SNAP ON UNLESS IT IS CONNECTED TO GUN.

Check bleed screw on the gauge unit is closed and open valve on bottle slowly , pressure will now start to fill the gun reservoir.

Fill to recommended pressure and then close valve on bottle.

Open bleed valve on gauge block and bleed air out of filler hose.

When you are sure system is empty remove Snap-On connector and replace dust cap.

The gun is now fully charged and ready for use.

Always leave air pressure in your rifle , this keeps valves properly seated and prevents internal deterioration .

General Maintenance Due to the special finish on the Harrier it is essential that you keep the external surfaces oiled with a good quality gun oil to ensure this finish is maintained.

Important Notice.. Whilst every care and attention has been taken to ensure only the best products have been used to manufacture your new gun we must ask you not to exceed the recommendations for the gun. The pressure chamber must always be kept in good order, should damage occur to this part, i.e. Denting, Rusting, Exposure to extreme heat or cold or any other apparent blemish we ask you to return the gun for inspection and pressure testing. Regular maintenance of any mechanical equipment ensures longer trouble-free life therefore routine inspection and service will help to give you accurate and consistent shooting. The recommended fill pressure must **not** be exceeded and care should be taken when filling to ensure all connections are tight and **do not** leak.

WARNING!!!!

Compressed air and oil are a highly combustible mixture. You **must not** under any circumstances put oil or spray oil anywhere near the inlet valve of your gun . Always have the dust cover in place when cleaning and oiling your gun.

You must **never** use oxygen in any pre-charged gun.

HARRIER SERIAL NO: **Fill pressure**

WARRANTY

12 month warranty on failure of any Daystate manufactured parts from date of purchase. Proof of purchase required.

Warranty does not cover: 1. Seals 2. Springs 3. Failure due to fair wear and tear or misuse or abuse.

Warranty is void if gun is adapted or fitted with parts other than genuine Daystate spares.

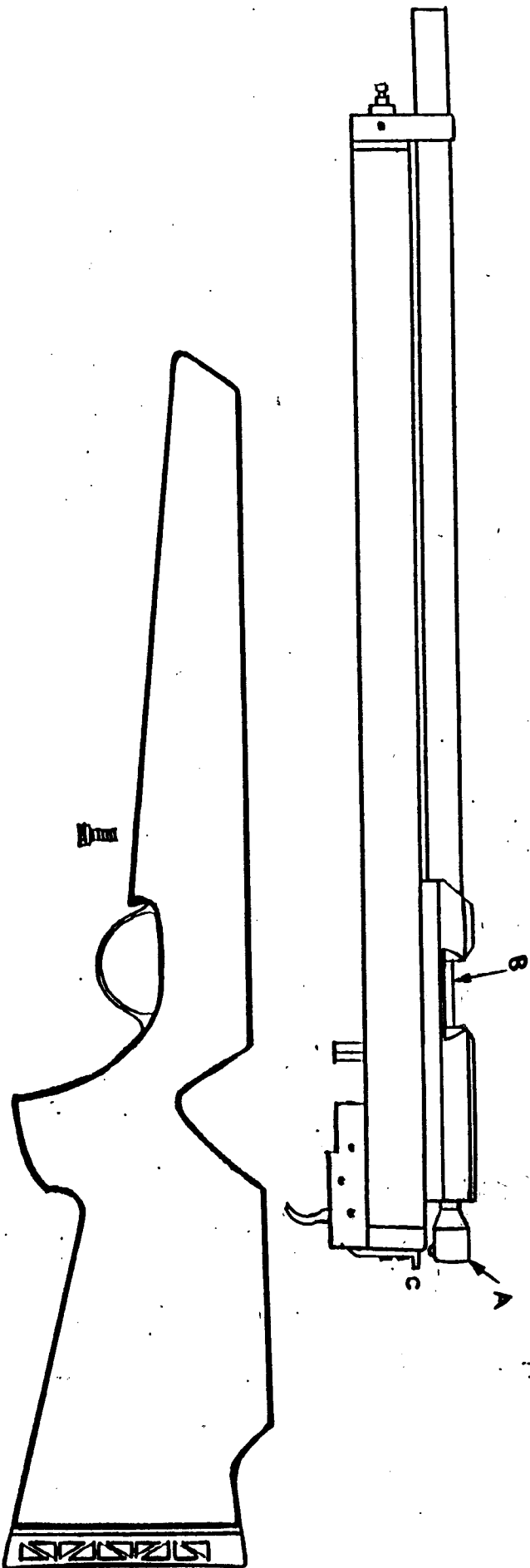

Recommendations and Maintenance.

1. A silicone cloth is recommended for the wiping down of the outside the gun once the air rifle has been handled and before the gun is put away.
2. Lubricating any moving parts i.e. The breech bolt part (a) should be with a silicone grease or synthetic grease.
3. The internal parts of any Daystate air rifle should be free from any grease or heavy duty oil, oil & grease will cause malfunction in the performance of the rifle.
4. Standard Beech stocks come with a lacquer finish which does not need any maintenance.
5. Deluxe Walnut stocks come with an oil finish, with an oil finish you can apply more stock finishing oils to enhance the looks and improve the finish.
6. **WARNING:** All guns fitted with a Snap-On connector should always check that the female connector is fully forward and locked before charging the gun.

Recommended Pellets

All Daystate guns are tested to comply with legislation to fall within the 12 ft lbs. muzzle energy in the UK, Unless a F.A.C. is produced.
The .177cal & .22cal rifles are tested with the Bisley Magnum.

DAYSTATE PARTS LIST FOR HARRIER MODEL

PART NO:	DESCRIPTION	QTY:
1	SOUND MODERATOR (Optional Extra)	1
2	MUZZLE BREAK (Optional Extra)	1
3	SILENCER ADAPTOR (Optional Extra)	1
4	BARREL CAP	1
5	FIXING SCREWS FOR PARTS 1-4	2
6	BARREL	1
6a	BRASS BARREL INSERT O RING	1
6b	BRASS BARREL INSERT	1
7	FRONT BREECH FIXING SCREWS	2
8	BREECH BLOCK	1
8a	BREECH BOLT COCKING PIN	1
9	BREECH BALL BEARING SPRING	1
10	REAR BREECH FIXING SCREW	2
11	SET SCREW FOR BALL BEARING & SPRING IN BREECH	1
12	BALL BEARING	1
13	BREECH BOLT O RING SEAL	1
13a	PELLET PROBE	1
14	BREECH BOLT	1
14a	BREECH BOLT COCKING KNOB & PEG (Standard on Harrier)	1
15	BRASS KNURLED BREECH BOLT KNOB	1
16	BRASS SWAN NECK COCKING BOOT (Optional Extra)	1
17	SWAN NECK COCKING BOOT FIXING SCREW	2
18	DUST COVER	1
19	DUST COVER O RING	1
20	BARREL SUPPORT	1
21	BARREL SUPPORT FIXING SCREWS	3
22	MALE SNAP-ON TAIL	1
23	MALE SNAP-ON TAIL VALVE (STAINLESS STEEL)	1
24	MALE SNAP-ON TAIL VALVE O RING	1
25	FILTER	1
26	FRONT VALVE BODY	1
26a	FRONT VALVE BODY O RINGS	2
27	MAIN AIR CYLINDER	1
28	PORT BUSH	1
29	PORT BUSH O RING	2
30	STRIKER VALVE BODY O RING RETAINER	1
31	STRIKER VALVE BODY O RING	1
32	STRIKER VALVE SPRING	1
33	STRIKER VALVE SEAL	1
34	STRIKER MAIN VALVE BODY	1
35	STRIKER VALVE STEM O RING	1
36	STRIKER VALVE STEM O RING RETAINER (BRASS)	1
37	STRIKER VALVE BODY FIXING SCREWS	2
38	STRIKER ADJUSTER SCREW	1
39	STRIKER ADJUSTER LOCKING SCREW	1
40	STRIKER	1
41	STRIKER GUIDE SCREW	1
42	STRIKER SPRING GUIDE	1
43	STRIKER MAIN SPRING	1
44	STRIKER SPRING RETAINING CAP	1
45	SAFETY CATCH BALL BEARING SPRING	1
46	SAFETY CATCH BALL BEARING	1
47	SAFETY CATCH	1
48	SAFETY CATCH FIXING SCREW	1
49	STOCK FIXING STUD	1
50	STRIKER MAIN VALVE BODY LOCATION DOWEL	1
51	STOCK FIXING NUT	1
52	TWO STAGE TRIGGER UNIT COMPLETE (SEE TRIGGER INSTRUCTIONS)	1

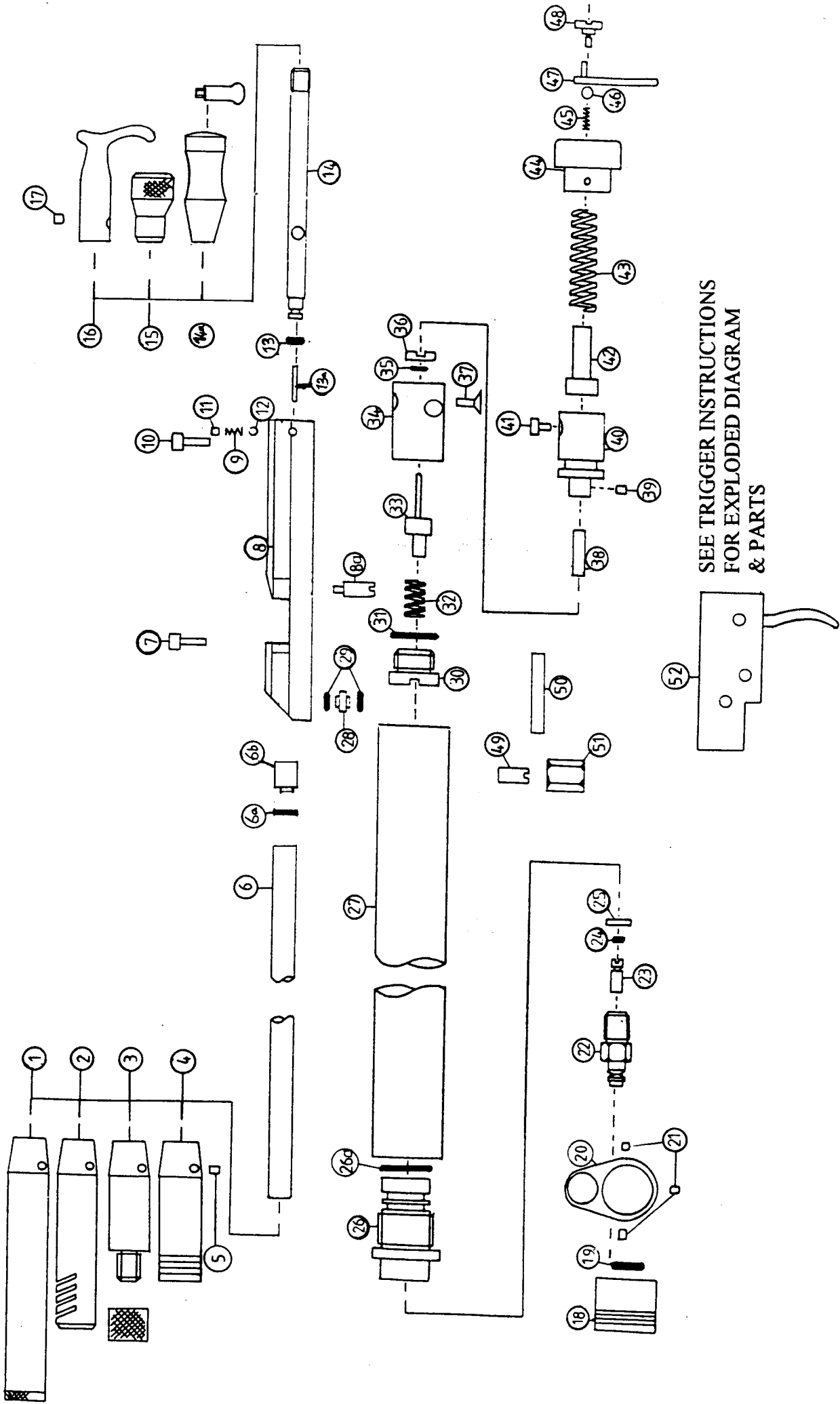

SEE TRIGGER INSTRUCTIONS
FOR EXPLODED DIAGRAM
& PARTS

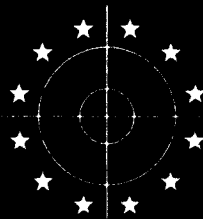

DAYSTATE LTD.

Small Arms Manufacturers

Birch House Lane, Cotes Heath, Staffs. ST15 0QQ. Tel: 01782 791755 Fax: 01782 791617

Maintenance & Service of DAYSTATE Products

STOCKS

WALNUT: This stock is finished with stock conditioning oil with approximately 3 to 4 coats applied to give a hard durable finish. Any further oiling should be done with a stock wax with a petroleum base.

With walnut having an oiled finish there is no requirements to strip the entire stock to repair the affected area. Just sand or wire wool the damaged area, then reseal with any stock oil or wax.

BEECH: All beech stocks are finished in an acid hardener lacquer. This finish gives the stock a darker look in appearance.

Please note: If the lacquer was to be removed the light beech wood will show through as being a very white wood. All marks such as scratches or dents can be removed the same as the walnut stock but to create the same finish the whole of the stock will require stripping and refinishing.

OUTSIDE THE ACTION.

All DAYSTATE products are chemically blued or anodised to give a deep lasting finish or a Matte anti-glare finish.

Which ever product is bought, care is required to keep your DAYSTATE in tip top condition so we recommend that any silicone or synthetic based product to be applied to a cloth then applied to the outside of your gun making sure you cover the entire area with an even amount to protect the metal parts.

Lubrication of the breech bolt should be of a light grease making sure that it does not enter into the pellet trough which in turn could enter up the barrel causing accuracy problems and power fluctuations.

WARNING

Do not put oil or grease around the inlet valve system or the quick fit unit. This may cause problems with seals if contact occurs.

Do not lubricate any internal moving parts such as the striker or the trigger mechanism unless its with a Lubro-Teknik product recommended by ourselves.

PELLET RECOMMENDATIONS

<i>up to 12ft lbs</i>	Bisley Magnums, Barracuda, Superdome, Field Target Trophy, Crosmans.
<i>up to 25ft lbs</i>	Bisley Magnums, Barracuda, Superdome, Field Target Trophy, Crosmans.
<i>up to 42ft lbs</i>	Bisley Magnums, Barracuda.
<i>50ft lbs and over</i>	Eley Magnums.

All technical information can be acquired by phoning DAYSTATE on the above telephone number.

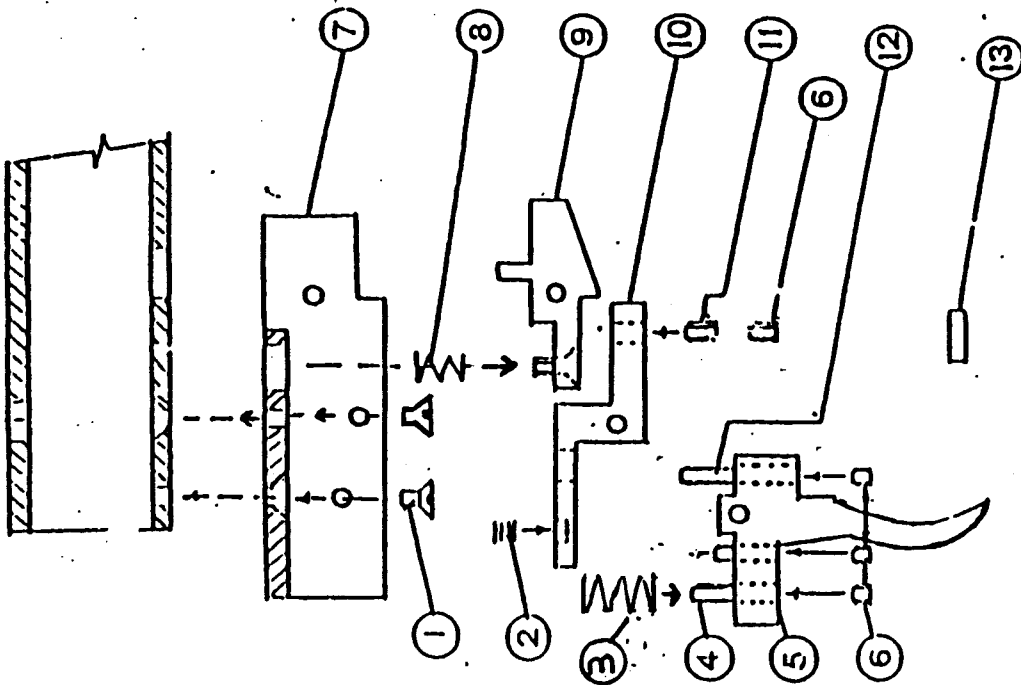

No	Description	Qty	No	Description	Qty
1	Trigger Block Fixings	2	8	Trigger Sear Spring	1
2	Trigger Lever Spring	1	9	Trigger Sear	1
3	Trigger Spring	1	10	Trigger Lever	1
4	Trigger Travel Screw	1	11	Trigger Lever Adjuster	1
5	Trigger	1	12	Trigger Angle Adjuster	1
6	Locking Set Screw	4	13	Dowel	3
7	Trigger Block	1			

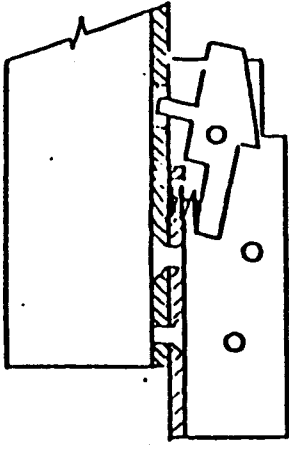

(A)

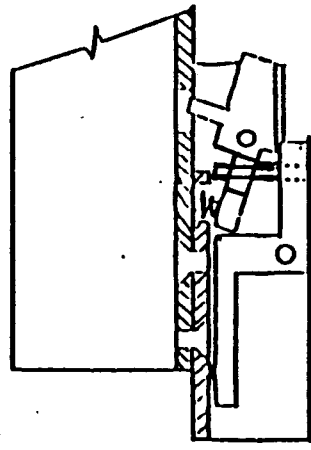

(B)

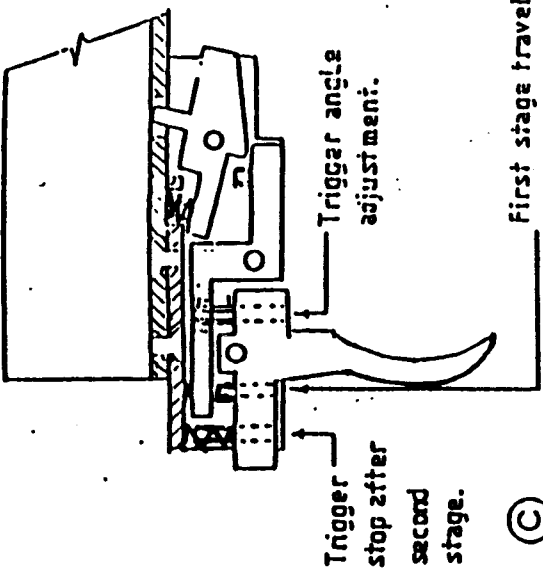

(C)

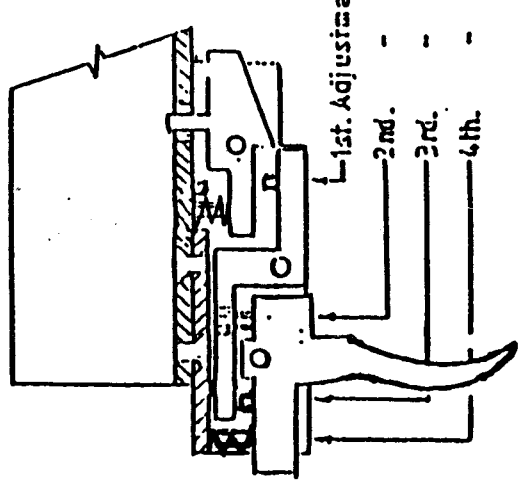

(D)

DAYSTATE

The Copyright of this drawing is the property of DAYSTATE LTD. This drawing is issued on the condition that it is not copied, reproduced or disclosed to a third party without permission.



DAYSTATE LTD.
Small Arms Manufacturers

Birch House Lane, Cotes, Staffs. ST15 0QQ. Tel: 01782 791755 Fax: 01782 791617
Email: daystate.ltd@virgin.net
Web: <http://www.daystate.co.uk>

DAYSTATE TRIGGER ADJUSTMENT INSTRUCTIONS

The diagram shows to the left an exploded view of the trigger components, then four boxes from A to D showing the assembly stages for the trigger mechanism.

Once assembled, the trigger can be adjusted to suit almost everybody's taste. See below for the necessary adjustments:-

SEE DIAGRAM "D" FOR THE ADJUSTMENT NUMBERS.

1st ADJUSTMENT This screw adjustment gives you the second stage weight setting, example if you want an increased weight setting the screw needs to be turned anti-clockwise, if you want a lighter setting you turn the screw clockwise. PLEASE NOTE if the screw is turned clockwise too much the trigger sear will not engage so your gun will not cock.

2nd ADJUSTMENT This screw adjustment is for setting the angle at which the trigger blade sits in your trigger block, factory setting is approximately 90° degrees to the trigger block. If you adjust this screw you will also need to adjust the 3rd and 4th adjustment screws to give you the necessary feel.

3rd ADJUSTMENT This screw adjustment gives you this first stage travel, anti-clockwise will increase travel and clockwise will reduce the travel.

4th ADJUSTMENT This screw adjustment is for the after travel of the trigger blade once the trigger mechanism has fired. The trigger stop is factory set to have a minimal amount of after travel once the gun has fired, if you require less travel turn the stop screw clockwise (PLEASE NOTE: If the stop screw is turned clockwise too much the trigger will not fire).

Anti-clockwise will give you more after travel once the gun has been fired.

PLEASE NOTE: ALL TRIGGER ADJUSTMENT SCREWS HAVE A LOCKING SCREW. THE LOCKING SCREW NEEDS TO BE REMOVED BEFORE YOU CAN MAKE THE NECESSARY ADJUSTMENT.

ADJUSTMENT TOOLS.

x1 Allen Key 1.5mm.

**This owner's manual was
provided as a service to you
by:**



www.airgunsofarizona.com

airguns_az@yahoo.com

Phone: (480)461-1113

Fax: (480)461-3928